

# HVRM-HD400H / HD800M / HD1600M

## Install & User's Guide

(v 1.3)



# Introduction

Thank you for purchasing a Hunt digital video recorder.

This manual is for **HVRM-HD400H/HVRM-HD800M/HVRMHD1600M**.

Before product installation and operation, please become thoroughly familiar with this user manual and other manuals referenced by this manual.

This user manual and the software and hardware described here are protected by copyright law. With the exception of copying for general use within fair use, copying and reprinting the user manual, either partially or in entirety, or translating it into another language without the consent of Hunt, is strictly prohibited.

This specification may change without prior notice for improvement of product performance.

## Product Warranty and Limits of Responsibility

The manufacturer does not assume any responsibility concerning the sale of this product and does not delegate any right to any third party to take any responsibility on its behalf. The product warranty does not cover cases of accidents, negligence, alteration, misuse or abuse. No warranty is offered for any attachments or parts not supplied by the manufacturer.

- ❖ **Malfunctions due to negligence by the user**
- ❖ **Deliberate disassembly and replacement by the user**
- ❖ **Connection of a power source other than a properly rated power source**
- ❖ **Malfunctions caused by natural disasters (fire, flood, tidal wave, etc.)**
- ❖ **Replacement of expendable parts (HDD, FAN, etc.)**
  
- ※ **The warranty period for the HDD and Fan is one year after purchase.**

**This product is not for exclusive use of crime prevention but for assistance in cases as fire or theft. We take no responsibility for damage from any incident.**

**Caution**

As this equipment undergone EMC registration and suitable for business purpose, distributors and users are aware of this point.

FCC Compliance Statement

**Caution** : Any changes or modifications in construction of this device which are not expressly approved the party responsible for compliance could void the user's authority to operate the equipment.

**NOTE** : This equipment has been tested and found to comply with the limits for a Class A digital device, pursuant to part 15 of the FCC Rules. These limits are designed to provide reasonable protection against harmful interference when the equipment is operated in a commercial environment. This equipment generates, uses, and can radiate radio frequency energy and, if not installed and used in accordance with the instruction manual, may cause harmful interference to radio communications, Operation of this equipment in a residential area is likely to cause harmful interference in which case the user will be required to correct the interference at his own expense.

**Warning**

This is a class A product. In a domestic environment this product may cause radio interference in which case the user may be required to take adequate measures

**Warning**

1. Risk of Explosion if Battery is replaced by an Incorrect Type. Dispose of Used Batteries According to the Instructions
2. In case of changing built-in lithium battery, it should be replaced as same or kindred one to prevent a danger of explosion. Since old batteries could be a factor of environment contamination, be cautious to treat them.
3. Do not throw the batteries to fire or heating. Neither short circuit or disassembly is prohibited.

**Important Notice**

1. Do not place heavy objects on the top of the product.
2. This equipment is indoor use and all the communication wiring are limited to inside of the building or similar texts.
3. Product is for indoor use. It is not weatherproof. Use product with referring to its environmental specifications (Temperature & Humidity). To clean the product, gently wipe the outside with a clean dry cloth.
4. Product uses AC power of 110V ~ 240V. Be cautious not to cause electric damages to product.
5. Be careful not to drop the product. Physical shocks may harm the product including internal HDD. In addition, be sure the product is secured after installation.
6. Product is made of metal. Therefore you can hurt human beings if you throw it to them or hit on them. When installing product, be cautious to locate on safe places where children are unreachable.
7. If Product does not operate properly, please contact the closest HUNT distributor for after sales service. Tampering or disassembling the product will void the warranty.
8. Security surveillance laws may differ for each country. Therefore, please contact the local region first to avoid any surveillance law violations.
9. "Rack Mount Instructions - The following or similar rack-mount instructions are included with the installation instructions:
  - A) Elevated Operating Ambient - If installed in a closed or multi-unit rack assembly, the operating ambient temperature of the rack environment may be greater than room ambient. Therefore, consideration should be given to installing the equipment in an environment compatible with the maximum ambient temperature (T<sub>ma</sub>) specified by the manufacturer.
  - B) Reduced Air Flow - Installation of the equipment in a rack should be such that the amount of

air flow required for safe operation of the equipment is not compromised.

C) Mechanical Loading - Mounting of the equipment in the rack should be such that a hazardous condition is not achieved due to uneven mechanical loading.

D) Circuit Overloading - Consideration should be given to the connection of the equipment to the supply circuit and the effect that overloading of the circuits might have on overcurrent protection and supply wiring. Appropriate consideration of equipment nameplate ratings should be used when addressing this concern.

E) Reliable Earthling - Reliable earthling of rack-mounted equipment should be maintained. Particular attention should be given to supply connections other than direct connections to the branch circuit (e.g. use of power strips)."

Experience and technical skills are needed for the installation of this product as an improper installation may cause fire, electric shocks, or defects. Any installation job should be performed by the vendor you purchased this product from.

The content of this manual can differ according to firmware or Software upgrading, and the standard and appearance of products may be changed for the improvement of quality without an advance notice.

# Contents

<b>INTRODUCTION .....</b>	<b>1</b>
<b>KEY FEATURES .....</b>	<b>10</b>
<b>INSTALL MANUAL .....</b>	<b>14</b>
<b>1. FEATURE .....</b>	<b>14</b>
<b>1.1 Supplied Accessories.....</b>	<b>14</b>
1.2 Description & Function.....	14
1.2.1 Front.....	14
1.2.2 Rear.....	17
1.2.3 REMOTE CONTROLLER.....	18
<b>2. INSTALLATION.....</b>	<b>20</b>
<b>2.1 Installation and Connection .....</b>	<b>20</b>
2.1.1 Connecting & Running.....	20
<b>2.2 Running OSD menu .....</b>	<b>21</b>
2.2.1 OSD menu configuration .....	21
2.2.2 Setting remote controller.....	22
2.2.3 Installation examples.....	24
2.2.4 Basic Setting.....	25
<b>2.3 Connecting and configuring DIO ports .....</b>	<b>30</b>
2.3.4 HDD.....	38
2.3.5 Remote monitor and control.....	39
2.3.6 External device connection.....	41
2.3.7 NVS04 connection.....	42

<b>USER MANUAL</b> .....	<b>44</b>
<b>3.MENU USAGE</b> .....	<b>44</b>
3.1 Menu Structure .....	44
3.2 Function Menu .....	44
3.3 Factory Reset.....	44
<b>4. MONITORING</b> .....	<b>49</b>
4.1 Basic Screen .....	49
4.2 Single Full Screen Mode .....	49
4.3 Multi Screen Mode .....	49
4.4 Screen Description .....	49
4.5 Auto Switch Mode (Sequence).....	49
4.5.1 System Standard Mode.....	49
4.5.2 User Sequence Mode .....	50
4.6 Event Screen .....	50
4.7 Zoom Screen Mode.....	51
4.8 Pause Live Screen .....	51
4.9 PTZ Control .....	52
4.9.1 Pan/Tilt/Zoom .....	53
4.9.2 Focus .....	53
4.9.3 Load Preset.....	53
4.9.4 Save Preset.....	53
4.9.5 Auxiliary On .....	53
4.9.6 Auxiliary Off .....	53
4.9.7 Menu .....	53

<b>5. PLAYBACK.....</b>	<b>54</b>
<b>5.1 Playback Mode.....</b>	<b>54</b>
5.1.1 Playback on Standard monitor .....	54
5.1.2 Playback function.....	54
<b>5.2 SEARCH MODE .....</b>	<b>54</b>
5.2.1 Time Search.....	55
5.2.2 Schedule Search.....	55
5.2.3 Event Search .....	55
5.2.4 Thumbnail Search .....	56
<b>5.3 Copy .....</b>	<b>57</b>
5.3.1 CD/DVD .....	57
5.3.2 RE4.....	58
5.3.3 AVI.....	59
<b>6. CONFIGURATION .....</b>	<b>60</b>
<b>6.1 Recording Structure .....</b>	<b>60</b>
<b>6.2 System Setup.....</b>	<b>60</b>
6.2.1 Date/Time.....	60
6.2.2 Disk.....	62
6.2.3 User Setup.....	68
6.2.4 Utility.....	69
<b>6.3 Network.....</b>	<b>71</b>
6.2.3 xDSL.....	73
6.3.2 WRS .....	73
<b>6.4 Device Setup .....</b>	<b>74</b>
6.4.1 Camera Setup .....	75
6.4.2 Monitor Setup .....	75
6.4.3 Audio Setup.....	76
6.4.4 Text Setup .....	77
6.4.5 Serial Setup.....	78



<b>6.5 Event Setup</b> .....	<b>79</b>
6.5.1 Event Check.....	79
6.5.2 Sync Event.....	80
6.5.3 Motion Detection .....	84
6.5.4 Sensor .....	85
6.5.5 Preset.....	85
<b>6.6 Recording setup</b> .....	<b>86</b>
6.6.1 Program setup.....	86
6.6.2 Manual/Schedule recording setup .....	87
<b>6.7 Configuration Tool</b> .....	<b>90</b>
6.7.1 Site Tree .....	90
6.7.2 Configuration Page .....	90
6.7.3 Menu .....	91
<b>7 WEB VIEWER</b> .....	<b>92</b>
<b>7.1 System requirement</b> .....	<b>92</b>
<b>7.2 Login</b> .....	<b>92</b>
<b>7.3 User Setup</b> .....	<b>93</b>
<b>7.4 Browser available</b> .....	<b>93</b>
<b>7.5 Monitor</b> .....	<b>94</b>
7.6.1 Screen division and changing video position .....	94
7.6.2 Move to Playback .....	95
7.6.3 Channel On/Off.....	95
7.6.4 Sensor Indication .....	95
7.6.5 Relay operation.....	95
7.6.6 Using Microphone.....	96
7.6.7 Event Data .....	96
7.6.8 Video Recording & Save.....	96
7.6.9 Using PTZ .....	96
7.6.10 Using Audio .....	97
7.6.11 Closing Video Channel .....	98

<b>7.6 Playback .....</b>	<b>98</b>
7.6.1 Video Division & Changing Channel.....	98
7.6.2 Image recording.....	98
7.6.3 Print .....	99
7.6.4 Backup.....	99
7.6.5 Web Monitor .....	99
7.6.6 Channel On/Off.....	99
7.6.7 Saving time & Checking Rec, Capacity.....	99
7.6.8 Searching Calander .....	100
7.6.9 Functional function at the button of monitor .....	100
<b>8. USER MANUAL FOR MOBILE VIEWER .....</b>	<b>101</b>
<b>TROUBLE SHOOTING .....</b>	<b>104</b>
<b>CHECK THE MANUFACTURING DATE.....</b>	<b>105</b>
<b>AVAILABLE HDD.....</b>	<b>105</b>
<b>COMPATIBLE CD/DVD LIST .....</b>	<b>105</b>
<b>PRODUCT SPECIFICATION .....</b>	<b>106</b>
<b>PRODUCT DIMENSION.....</b>	<b>110</b>
<b>Open Source License Report on the Product.....</b>	<b>110</b>

## KEY FEATURES

### HD-SDI

This product can transfer HD (High-Definition) signal image using HD-SDI technology via coax cable. Please be noted that this product doesn't accept SD signal. The supportable resolution is below.

- **SMPTE 296M : 1280x720p 30/60Hz**
- **SMPTE 274M : 1920x1080p 30Hz**

### Monitoring Screen

Supports real live video with high resolution per each channel and variable display mode.

- **Various monitoring**  
**Single, 4 screen division, 9 screen division, 16 screen division**
- **Auto Switching(AUTO)**

### Audio Recording

Supports real-time audio input and recording

- **Simultaneous 4ch audio input & recording available**
- **Input : 4ch RCA, Output : 1ch(Rear)**
- **Simultaneous audio recording and playback available**

### Recording

It supports Max 120ips recording in high-quality HD-SDI video and available to record max. 5 seconds before triggering an event. Also, covert function is available protecting privacy (Covert func.).

- **HD SDI video record**  
**HVRM-HD400H : 1920 x 1080(1080P) : 60ips**  
**HVRM-HD800M/HD1600M : 1920 x 1080(1080P) : 120ips**

**HVRM-HD400H : 1280 x 720(720P) : 120ips**

**HVRM-HD800M/HD1600M : 1280 x 720(720P) : 240ips**

- **Supports manual & schedule recording**
- **Video loss detection**
- **Supports archiving event list (Sensor, Video loss, Motion detection, Text)**

**Available record Max 5 seconds before triggering an event per each channel**

### Search / Playback

It supports variable and convenient functions for search & playback.

- **Play back by time,date,channel**
- **Easy and convenient search using mouse**
- **Pre/Post search from a freeze frame**
- **Play back by Event (Sensor, Video Loss, Motion Detection, Text)**
- **Easy search by Remote controller**

### Back up device

It is available to back up to DVD-R,CD-R,USB memory by user's choice

- **Supports various back up device : DVD-R, CD-R, USB**
- **HDD external unit (recordin unit for external capacity expansion)**

### Network

It supports variable network like LAN, XDSL and easily control from remote site using PC client viewer.

- **E-mail notification thru, TCP/IP, DHCP in case of triggering an event**

- **Live monitoring form remote site (Whole screen or available to select quad screen)**
- **Available to playback, recording, search and DVR management thru. network viewer in PC**
- **Available to record, search & playback by time from remote site.**
- **Supports 10/100Mbps Ethernet/xDSL**
- **Multiple DVR connection**

ETC

- **Supports User friendly GUI and mouse function**
- **Supports User friendly GUI and mouse function**
- **Easy and simple firmware upgrade thru. USB memory**
- **PTZ Control (SPEED DOME), PRESET fucntion**
- **Available to control up to 16 DVRs with one remote controller**
- **Event information (Image) transmission feature using Twitter**



# Install Manual

## 1. Feature

### 1.1 Supplied Accessories

Unpack and check all the items as below

AC Cord, Remote control, Setup CD, HDD Fixing Screw, Rack Mount

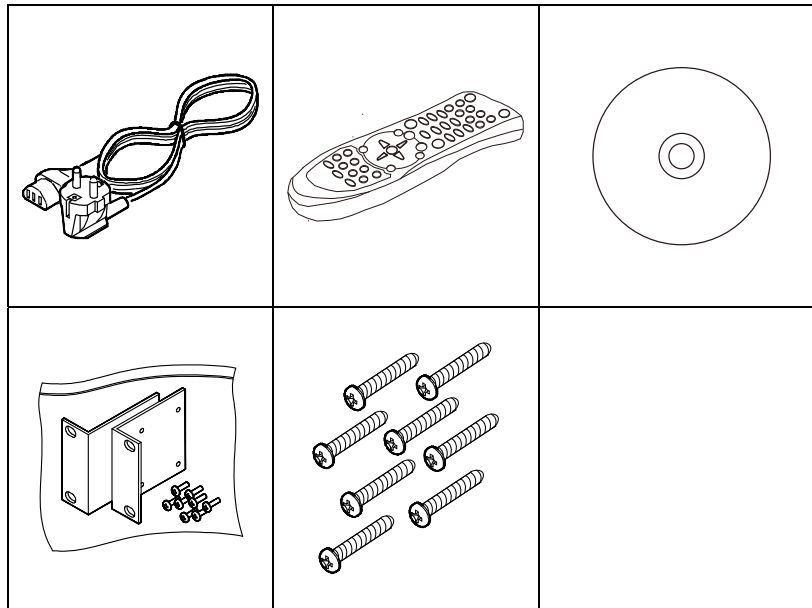

### 1.2 Description & Function

#### 1.2.1 Front

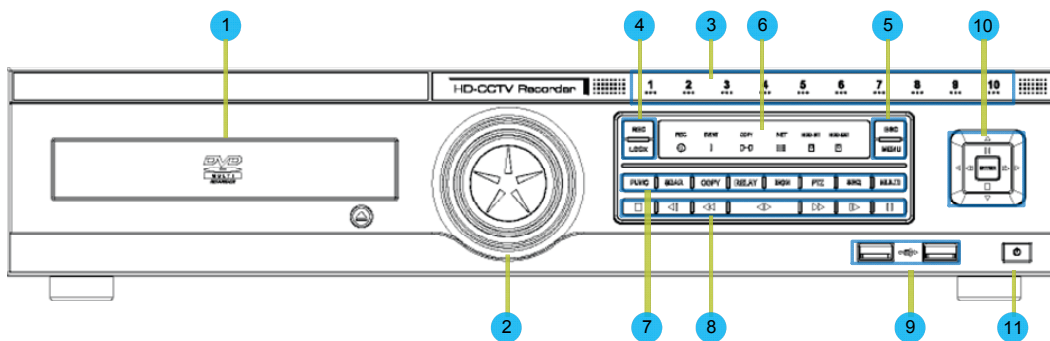

Category		Function
1	DVD-Multi for Back up	Back up use for recorded data by DVD/CD media
2	Jog / shuttle	Playback direction change and speed control
3	Touch Panel switch / channel LED	To select single channel with illuminating of relevant channel LED
4	REC	To start and stop recording
	LOCK	To lock the buttons on the front panel/remote controller in monitoring status
5	ESC	To exit menu or close pop-up window.
	MENU	To enter Menu
6	Recording LED	Display recording status.
	Event LED	Display event status
	Copy LED	Display copy status
	Network LED	Display network status
	Internal HDD LED	Display recording status to internal HDDs
	External HDD LED	Display recording status to external HDDs by eSATA
7	FUNC	To start Function menu
	SEAR	To start Search mode
	Copy	To run copy mode.
	Relay	To run and pause Relay action by manual.
	ZOOM	Expands live/playback screen
	Sequence	To run or stop user sequence.
	Multi	To change DVISION in live or playback mode.
8	■(STOP)	To stop replay in playback mode.
	◀I(SREW)	To move to reverse direction by one frame
	◀◀(REW)	To move or select in menu and change replay speed to reverse direction in playback mode
	◀▶(PLAY)	To select playback mode and change playback direction
	▶▶(FWD)	To move or select in menu and change replay speed to forward direction in playback mode.
	I▶(SFWD)	To move to forward direction by one frame
	II(PAUSE)	To move or select in menu and pause live/ replay video.



## Install&User's Guide

---

---

9	USB port	Use connecting USB memory or Mouse
10	◀(Left Move)	To move to left in menu
	▶(Right Move)	To move to right in menu
	▲(Upper Move)	To move to upper in menu
	▼(Down Move)	To move to lower in menu
	Enter	To select menu or enter the selected menu
11	Power	To turn On/Off power

### 1.2.2 Rear

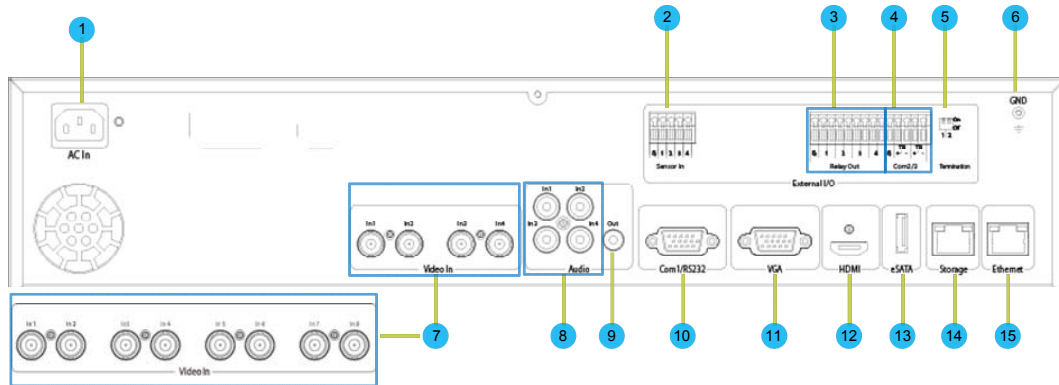

No	Name of Input/Output	Function
1	Power connector	Socket for AC100V~AC240V power cord.
2	Sensor IN	Input for external sensor.
3	Relay	Relay Connection terminal.
4	Com2,3	For RS-485
5	RS-485 Termination	RS-485 Termination Switch
6	Ground	Ground between DVR & external device.
7	CH1~4(8)(16)	BNC input for camera connection
8	Audio input(RCA)	RCA connection for Audio input
9	Audio output	Speaker output terminal.
10	Com1	RS-232C D-SUB.
11	VGA Output	Video output port to connect PC monitor.
12	HDMI Output	HDMI output port to connect PC monitor.
13	eSATA port	For eSATA external HDD connection
14	Storage	For external HDD connection
15	Ethernet	For network connection (RJ-45)

### 1.2.3 REMOTE CONTROLLER

It is available to use all functions of DVR. If several DVR are set with unique ID numbers, they can be controlled with one remote controller. To use remote controller, it is necessary to set ID first which want use. Keep pressing ID button repeatedly (Up to Max. 16 times) and use it matching DVR & ID.

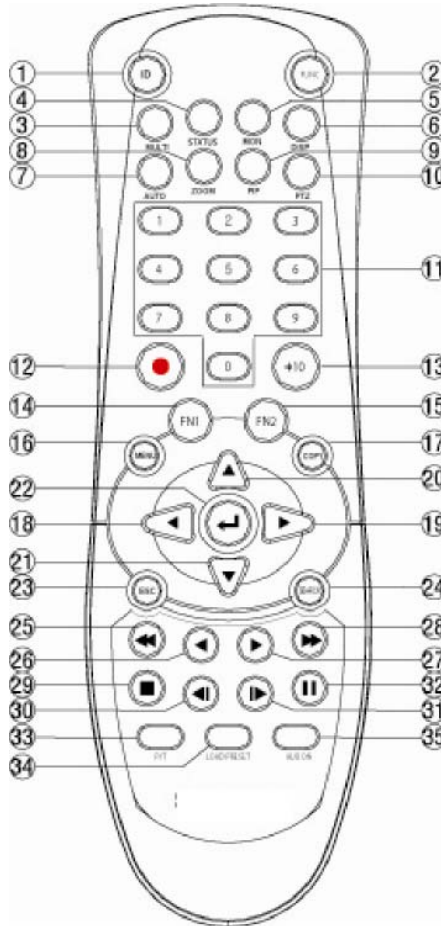

No.	Item	Description
1	ID	To select Remote Controller ID
2	LOCK	Not use
3	COPY	To indicate copy menu, copy recorded data to USB
4	BACKUP	Not use
5	RELAY ON	To manually ON
6	RELAY OFF	To manually OFF
7	SEQ	Auto sequencing
8	MULTI	To change division

9	ZOOM	To run digital zoom
10	SEARCH	To indicate search menu
11	CHANNEL BUTTON	To select channel
12	SELECT	Not use
13	+10	In case of selecting over 10 (+10 + 1)
14	MON(Action Zoom)	To run digital zoom
15	REC	To start/stop recording
16	MENU	Covert to menu screen
17	HELP	To start Function menu
18	◀/REW	Move setting menu to left direction/REW
19	▶/FWD	Move setting menu to right direction/FWD
20	▲/PAUSE	Move setting menu to top direction/PAUSE
21	▼	Move setting menu to bottom direction/STOP
22	ENTER/PLAY	Menu selection/Playback
23	ENTER	To select menu
24	EXIT	To cancel setting, escape from menu
25	FAST REWIND(◀◀)	Speedy replay to reverse direction
26	REWIND PLAY(◀)	Replay to reverse direction
27	FORWARD PLAY(▶)	Replay to forward direction
28	FAST FORWARD (▶▶)	Speedy replay to forward direction
29	STOP(■)	To stop replay
30	STEP REVERSE(◀ )	Replay to reverse direction by each frame
31	STEP FORWARD ( ▶)	Replay to forward direction by each frame
32	PAUSE(II)	To freeze playback
33	PTZ	To start PTZ menu
34	LOAD PRESET	To read preset
35	SAVE PRESET	To save preset

## 2. Installation

### 2.1 Installation and Connection

#### 2.1.1 Connecting & Running

##### 2.1.1.1 Connecting camera

Connect CCTV camera to DVR with BNC cable as below.

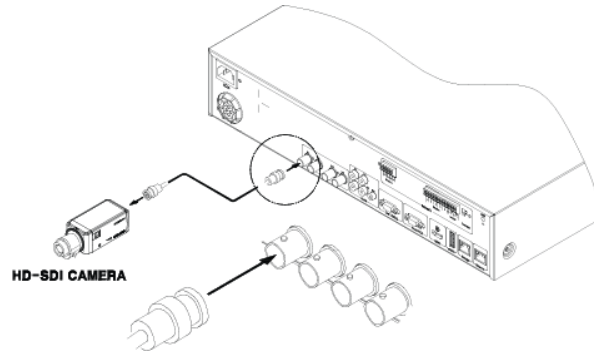

Please make sure to connect standard camera following HD-SDI rule. (HD-SDI)

##### 2.1.1.1 Connecting monitor

Connect CCTV monitor to DVR with HDMI cable as below.

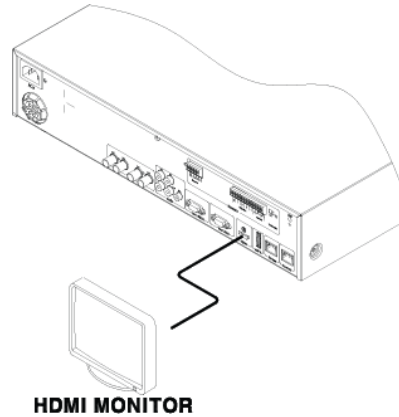

##### 2.1.1.2 Connecting Audio

Connect audio signal to DVR with using RCA cable or D-SUB as below.

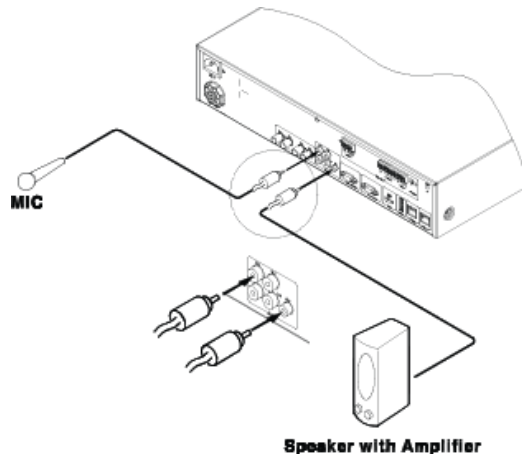

### 2.1.1.3 Supplying Power

Connect power cable as below.

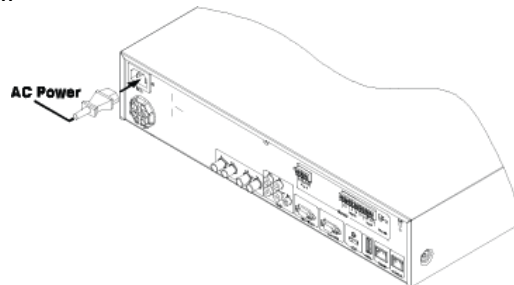

- When supplying power, DVR starts booting automatically.
- In order to cut off power, press power switch on DVR front during 5 seconds, then select "YES" after appearing a pop-up window.
- For supplying power again, push the Power button.

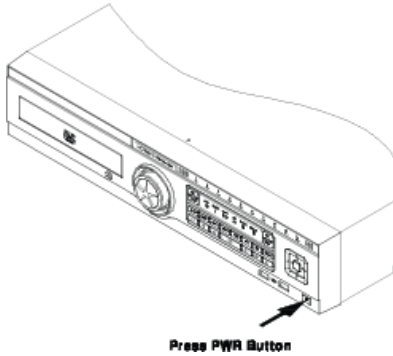

## 2.2 Running OSD menu

### 2.2.1 OSD menu configuration

Press [MENU] in keypad of front or Click in [Main Menu] in Function menu to open configuration menu as below.

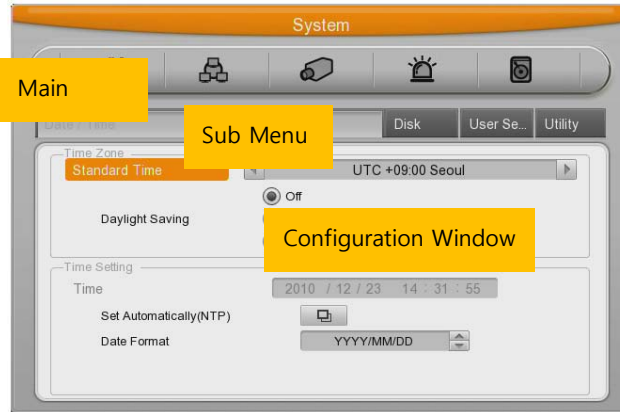

(1) **Main Menu** : The selected tab is show in bright color and the related sub-menu will be shown left-below the tab. To move to the previous/next tab, use the [◀/▶] arrow buttons. To move to a sub-menu press the [Enter] key or click the mouse button when you use mouse.

(2) **Sub-menu** : The selected sub-menu is shown as tab title and the related setting will be shown. To move to the previous/next tab, use the [◀/▶ ▲/▼] arrow buttons. To move to the related setting press [Enter] or click the mouse. To move to upper main menu, press [ESC] button.

(3) **Setting page** : The selected tab is shown as orange, To move to the previous/next tab, use the [◀/▶] or [▲/▼] arrow button or click the mouse. To configuration setting, press [Enter] key for value setting or click the mouse. When setting value is a word, a dialogue box to edit the word will be open. When setting value is number, it should be set with using [◀/▶] or [▲/▼] or click the related numbers by mouse. Press [ESC] button or click [Enter] by mouse when the value is set. Also [ESC] button or click the mouse is available to upper sub-menu.

### 2.2.1.1 Dialogue box to edit a word

Dialogue box to edit a word is image shown as below; It is available to input both word and bomber.



Keep pressing [▲/▼], [◀/▶] arrow button until the word is looking for and press [Enter] or click the mouse. In case of deleting input word press [←], spacing words press [→] button. To exit from dialogue box, press [Enter] or click [Enter] button by mouse after finishing word input.

## 2.2.2 Setting remote controller

### 2.2.2.1 Setting ID of DVR

When controlling several DVRs with one remote controller, set Remote Control ID as follows.



- (1) Press the [MENU] button
- (2) [▶] Select "system" with using [▶] arrow button and press [Enter] or [▼] button
- (3) [▼] Select "Utility" with using [▶] arrow button and press [Enter] button.
- (4) Select "Remote Control ID" and press [Enter]
- (5) [◀/▶] Select a value using [◀/▶] arrow buttons and press [ESC]
- (6) Press the [ESC] button to return to the monitor mode.

**<Reference>**

**Up to 16DVRs can be controlled with a single remote controller.**

**When not using remote controller, set the Remote Control ID as "Off"**

**2.2.2.2 Setting ID**

If several DVRs are with unique ID numbers, they can be controlled with one remote controller. To select a specific DVR, keep pressing the ID button of remote controller until a buzzer sounds during 2 seconds.

**2.2.2.3 Operable range of remote controller**

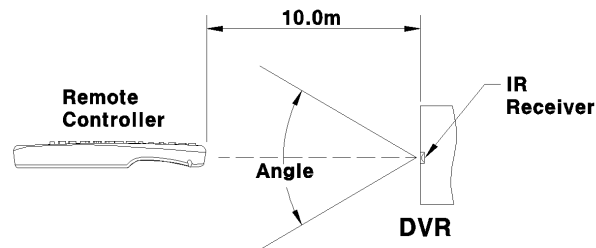

**Horizontal Angle : ± 30°**  
**Vertical Angle : ± 30°**

**2.2.2.4 Loading the batteries into the remote controller**

Remote controller required two AAA-type batteries. Please, refer the following installation step.

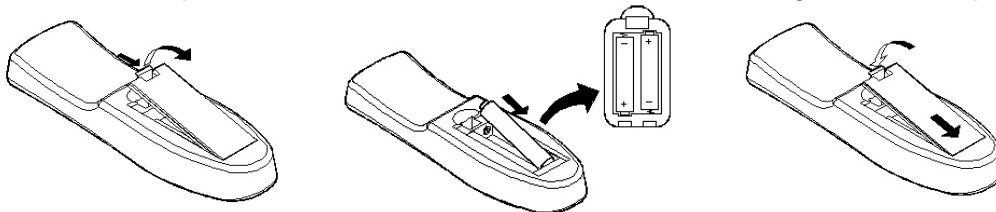



1. Remove the batter cover.
2. Taking care the poles (+/-) are correctly positioned
3. Replace the batter cover.

## 2.2.3 Installation examples

### 2.2.3.1 Basic configuration

Connect camera and monitor and Audio.

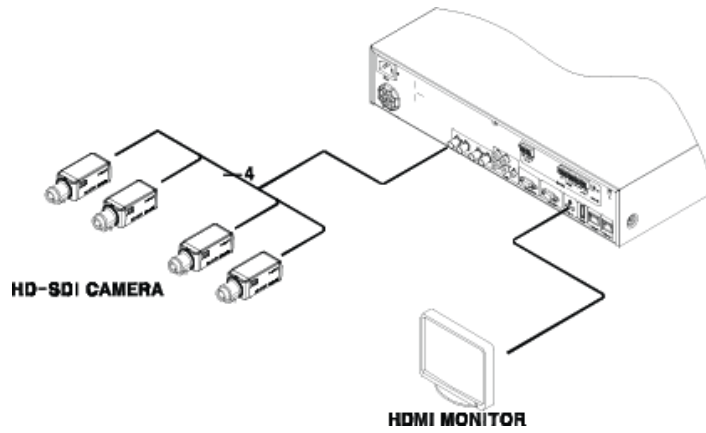

### 2.2.3.2 Advanced configuration

Connect camera, monitor, audio, sensor, relay etc.

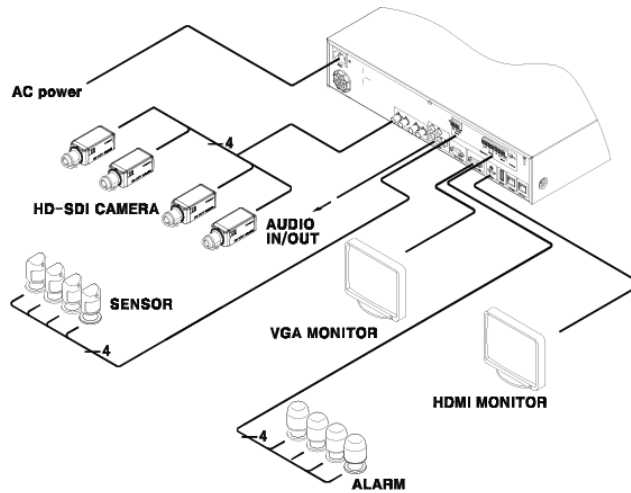

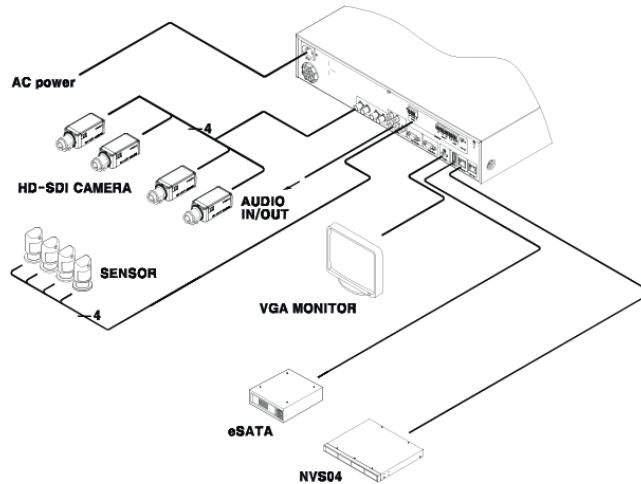

### 2.2.3.3 External storage & back up configuration

Use USB for back up.

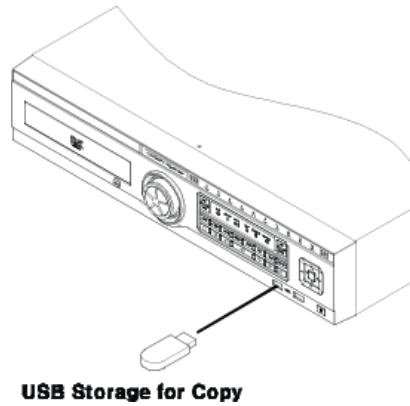

### 2.2.3.4 Internet / Intranet configuration

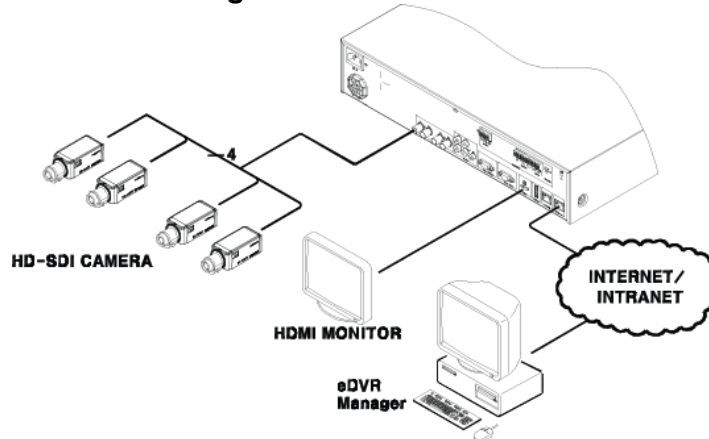

## 2.2.4 Basic Setting

### 2.2.4.1 Viewing Image

When power is on, eDVR starts automatically and displayed in basic 4ch(9ch)-split screen after booting.

<Reference>

If user password is set, a prompt for entering the password will be appeared. Factory default is reserved as not responding keypad on DVR front (It is not from factory default).



### 2.2.4.2 Setting Date & Time

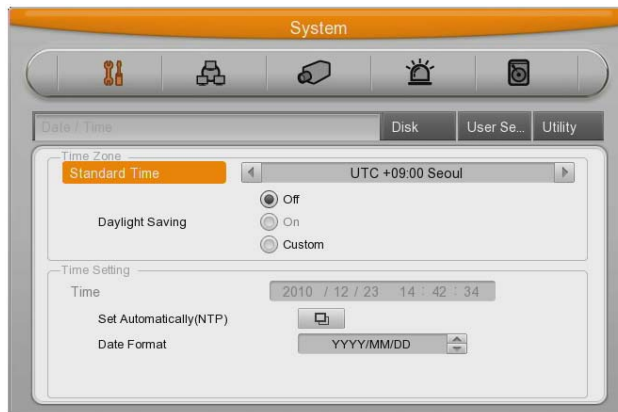

- Press [MENU] button and select "System" when OSD menu is appeared.
- Select "Date/Time" and press [Enter] button.

#### Time Zone

Use the left or right arrow key on the front or the mouse wheel to select your time zone. Each press of the arrow keys changes the time zone. (To go to the previous menu, press the [ESC] button on the front or right-click. This is the same for all OSD menus.)

#### Daylight saving

This menu is linked with "time zone" setting. For example, if the countries applied for daylight saving in time zone setting menu then daylight saving will be turn to ON and other countries are not applied for daylight saving then this option will be turn to OFF, and additionally the user can configure the daylight saving option manually for the countries that were not applied, and in this case, you can use "Custom" option to set.

The second is for selecting a month, week, and day to define the start and end times of DST.



### NTP

- (1) Select yes or no of using NTP.
- (2) Select NTP mode among Client, server, Both using directional key. [◀/▶] or [▲/▼]
- (3) Select Public or Both.
- (4) Enter server IP address when configuring server type by Local.
- (5) Configure communication interval with server.



### DATE FORMAT

- (1) Select "Date Format" using [◀/▶] or [▲/▼] arrow button and press [Enter] button. Select a value using [◀/▶] arrow button from YYYY/MM/DD, MM/DD/YYYY, DD/MM/YYYY.
- (2) Press [ESC] after finishing value setting.

### TIME

- (1) Select "Time" using [◀/▶] or [▲/▼] arrow button and press [Enter] button.
- (2) Select Date, Time using [◀/▶] arrow button and set value using [▲/▼] arrow button.
- (3) Press [ESC] after finishing value setting.

### APPLY

Most setting values are applied automatically, when exiting form the related menu page. But "Date" & "Time" setting are not applied automatically because they may critically affect the file system of the recorded HDD. To apply Date/ Time settings confirm with [Apply Date/Time] buttons.

- (1) Select "Apply Date/ Time" using [◀/▶] or [▲/▼] arrow button and press [Enter]. Then, a warning message will be appeared as below image;
- (2) Select using [◀/▶] or [▲/▼] arrow button and select "YES", then, press [ENTER] button. To cancel, press [ESC] button.

### 2.2.4.3 Record Setting

Select "Record" pressing menu button in front.

#### Manual Setting

Manual record can be configured in "Program" of record menu and Manual / Event record is Available to Start/Stop with pressing [REC] button on front panel.

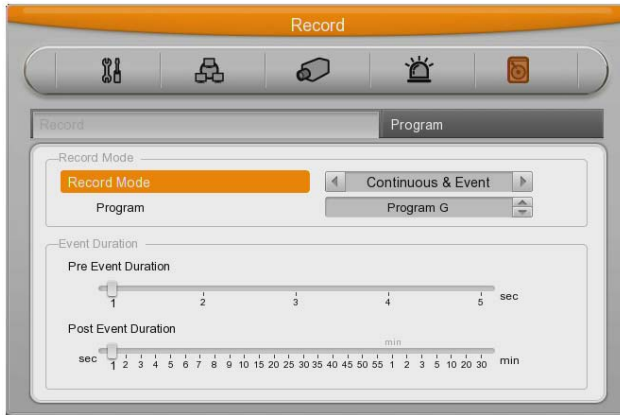

#### Schedule Setting

Set the recording schedule by each channel that user want record in "Program" of record menu. Set recording mode as "Schedule & Event" and set by date/ time.



#### Program Setting

Please setup resolution, frame rate, picture quality of connected camera per channel in "Program menu" of record setup. (Please refer to "record menu" for further explanation)



<Reference>

If recording setting is finished correctly, "REC LED" in front is flickering. In addition, it is marked [SCHEDULE] indicating that all channels are recording.

## 2.3 Connecting and configuring DIO ports

### 2.3.1 Wire Handlin

When connecting a wire to a terminal block, follow the instruction below. Not the different type of wire that can be used

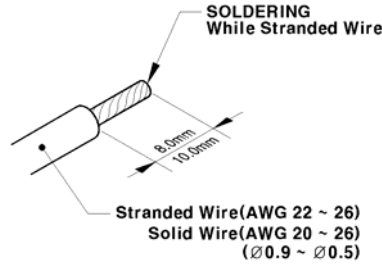

- Standard wire : Pie off the wiring cover 8~10mm and solder it. Wire gage should AWG 22~26.

- Sold wire : Peel off the wiring cover 8~10mm and solder it. Wire gage should be AWG 20~26.

### 2.3.2 Inserting & removing wire

To insert & remove wire in Terminal Block, use a screw driver in the diagram like below.

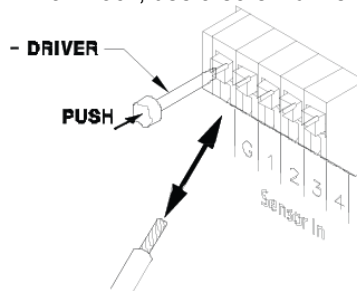

### 2.3.3 Conneting and configuring sensor

#### 2.3.3.1 Specification

In order to run sensor input DVR normally, the following conditions are required.

Spec	Input Ch	4EA(8EA)/(16EA) Transistor input
	Input type	N.C, N.O supprt
	Supported sensor	Dry contact sensor
	Way of connecting	Connecting the trimmed wire to terminal block
Performance	Available input pulse range	Minimum 500ms
	Output current	Typical DC 12mA

#### Connecting sensor input

Connect S1 ~ S4 with referring the following image. It shows to connect a dry contact (Please refer "Wire Handling").

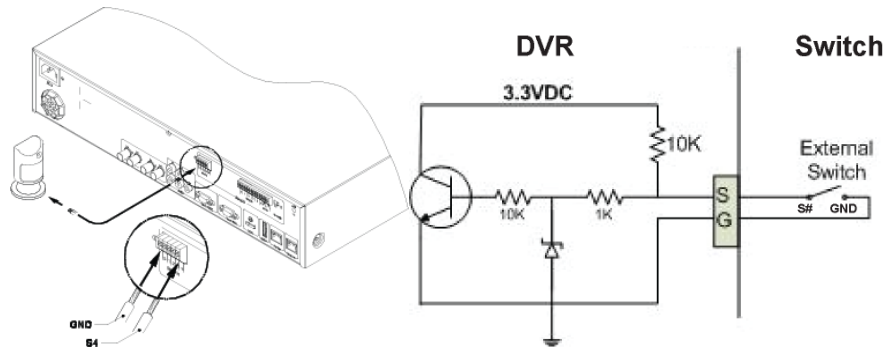

### Setting Sensor

- (1) Press [Menu] button and select “Event” when OSD menu is appeared.
- (2) Move to sub menu pressing [Enter] or using [▼] button and select [Enter].

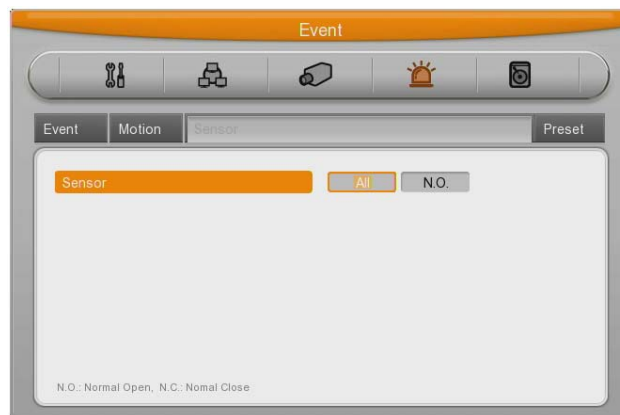

#### All Sensor

It is used when setting for all sensors and set Off, or Normal Open (N.O.) / Normal Close (N.C.) type.

- (1) Select All and set type.

#### Each sensor

It is used when setting for each sensor and set selecting each sensor.

- (1) Select sensor and press [Enter] button.
- (2) Select sensor that user want set and set type.
- (3) Press [ESC] after finishing value setting.

### 2.3.3.2 Connecting relay and stting

#### Specification

In order to run relay output of DVR normally, the following conditions are required.

SPEC	Output Ch.	4EA relay outputs
	Output type	Dry contact
	Connecting type	Connect the trimmed wire to terminal block
Performance	DC	30V 1A



	AC	125V 0.5A
--	----	-----------

### Connecting relay out

Connect R1 ~ R4 with referring to the following images, it shows to connect a warning light. Please refer the "Wire Handling"

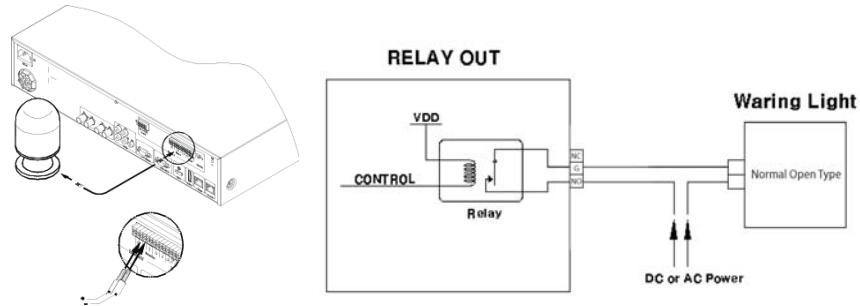

### Relay setting

It is available to run relay selecting from sensor, motion detection, Text, Video Loss which is normal event source and Disk error, Disk full, Fan error, authentication fail, WRS registration fail, Mirroring fail, abnormal Recording stop which is system event source. Also, user can set working condition by schedule. In case of using control center thru. Network, relay could be run from remotely

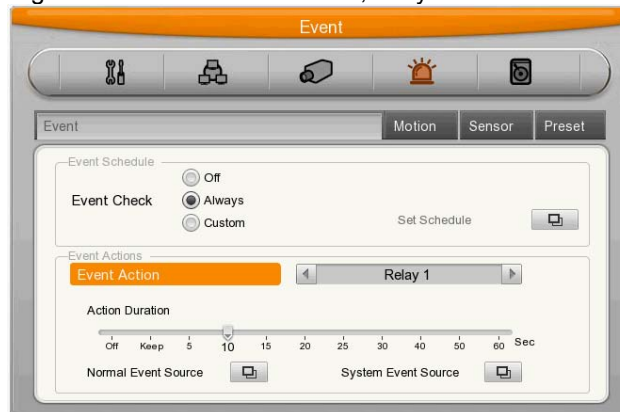

### 2.3.3.3 Connecting serial port

#### Configuring serial ports for Pan/Tilt/Zoom

If DVR supports thru. COM port, it is available to connect PTZ camera and control it. For a list of supported protocols, please refer to the list on the OSD configuration menu. The following figure shows how to connect PTZ camera to RS485 (COM2). When using another serial port, connect it with referring to each connection diagram below.

Please refer the "Wire Handling".

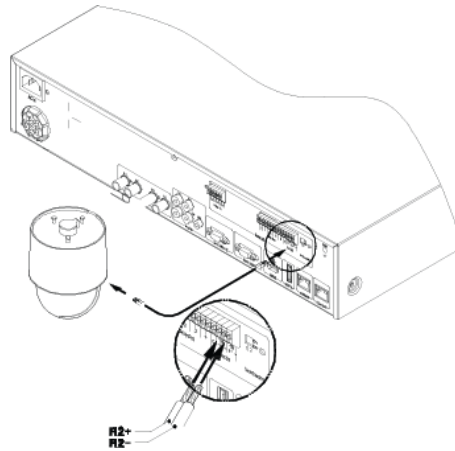

Serial communication port diagram  
COM1 connection diagram (RS-232 – D-Sub)

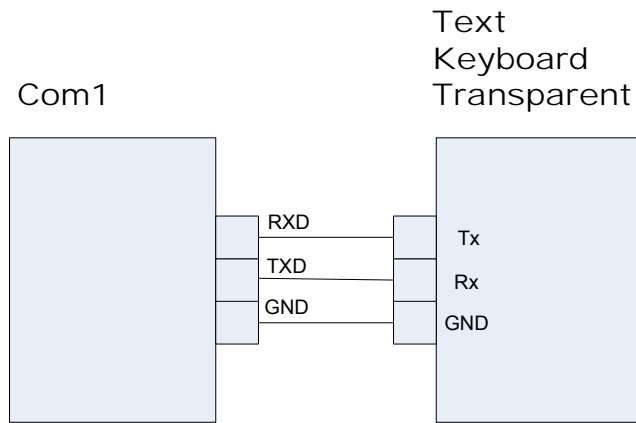

COM2/COM3 diagram (RS-485)

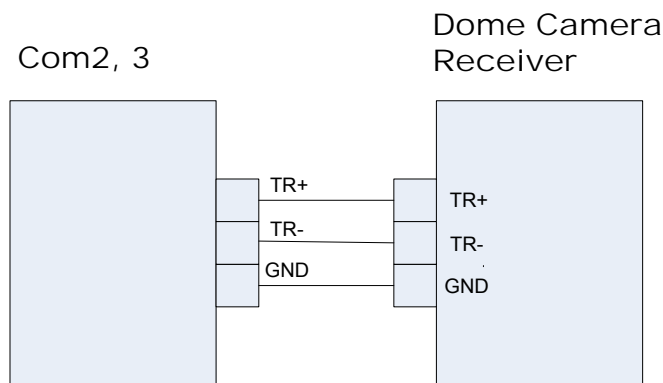

Available PTZ is as below

Model	Manufacturer
Keyboard KBD300A, WGI SPD1800/2600	Webgate
WKC-100 Keyboard	Webgate

PELCO(P), PELCO(D)	Pelco
BOSCH AutoDome, TC8560X-4	Bosch
Sony EVI-D3x	Sony
VT VPT-4x	VT
AD SpeedDome	AD
SungJin SJ372R1	Sungjin
Samsung SCC641	Samsung Electric
Panasonic WV-CS850	Panasonic
SDZ160/330, Samsung SPD, Keyboard SCC3000A, Samsung SRX-100B	Samsung Techwin
LG GAC-PT2	LG
Merit-Lilin FastDome	Merit
Elmo PTC200C	Elmo
Canon VC-C4	Canon
HTC-230S	Dongyang Unitech
RVision	RVT
Elbex	Elbex
Honeywell 755/655, HRX-2000, HTX-3000, ScanDome2	Honeywell
VIDO	VIDO
VICON	Vicon
Hunt	Hunt
ORX-1000	Systemenia
Fine CRR-1600	LiveEye
Tokina	Tokina
Kodicom KRE	Kodicom
Nuvico	Nuvico

**Serial Setting**

You can set up at 'serial' menu under Device menu.

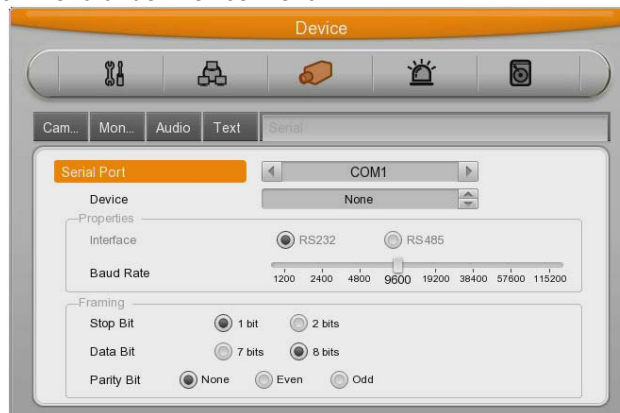

From serial setting, you can set protocol, port, baud rate, parity bit, stop bit and data bit. After completed serial setting, select desired channel from camera menu, and setting up PTZ Home, PTZ Idle Time, PTZ Port, and PTZ address.



### 2.3.3.4 Connection to external device via Serial port Text input device connection (ATM / POS / Access Control)

Using COM1/RS232, TEXT DATA can be recorded with synchronizing POS/ATM.

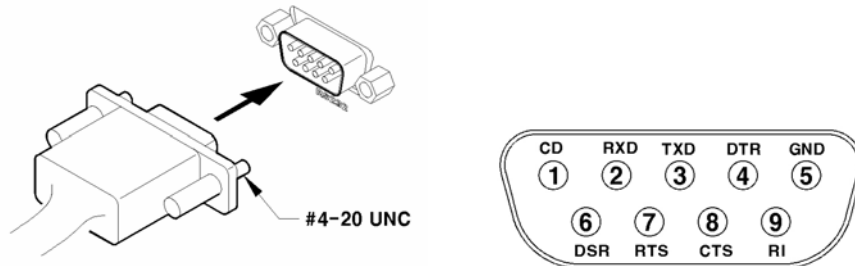

Like above picture, connect COM1/RS232 (9pin D-Sub) in Device menu and configure Serial and Text

#### Serial (COM1) Setup



- (1) OSD Select "Device" in OSD menu and move to sub menu.
- (2) Selecting COM1 and configure "Text" in Device
- (3) Setup the value of Baud Rate/Parity/Stop bit/Data bit with the device.

#### Text Setup

- (1) Select "Deice" on OSD, and move to sub menu.
- (2) Select "Text" and configure relevant text information.



**<Reference>**

Since external device cannot be recognized, before installing, please, ask to the shop.

**2.3.3.5 USB Device Connection**

USB port is for the video copy of small data or for USB mouse. Its recommended specification is same as below.

USB Spec.	Ver 2.0
Supported device types	USB Memory Stick
Output voltage/current	Max. 200mA per DC 5V / Port

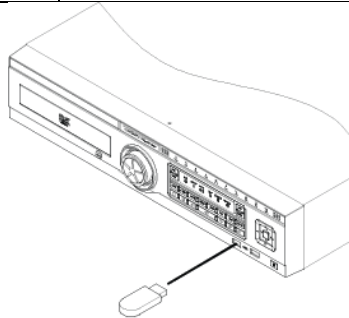

**USB Storage for Copy**

**<Reference>**

It should be formatted by FAT32.

In case of normal connection, if executing Copy menu, disk will be recognized same as Below and Set copy range → Select Drive → Execute Copy

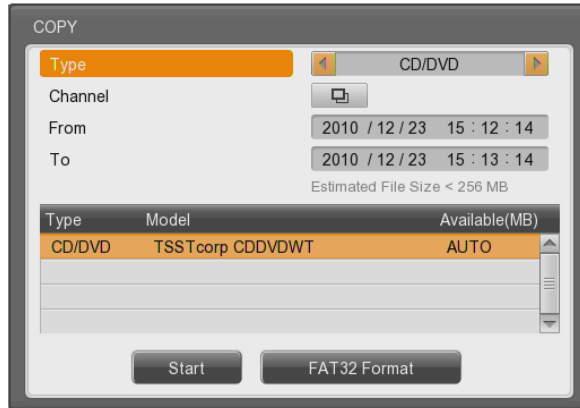

[CD/DVD Copy]

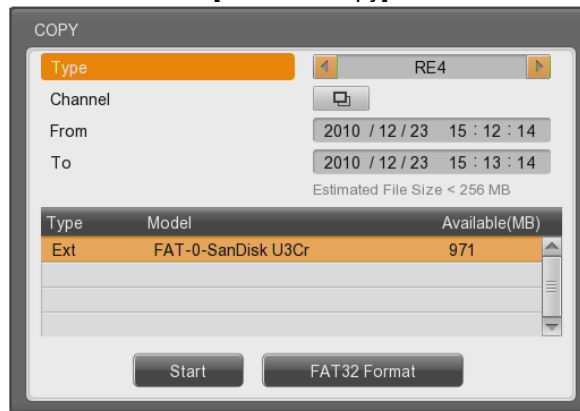

[RE4 Copy]

Select the channel to copy.  
Standard setting is selecting all channels

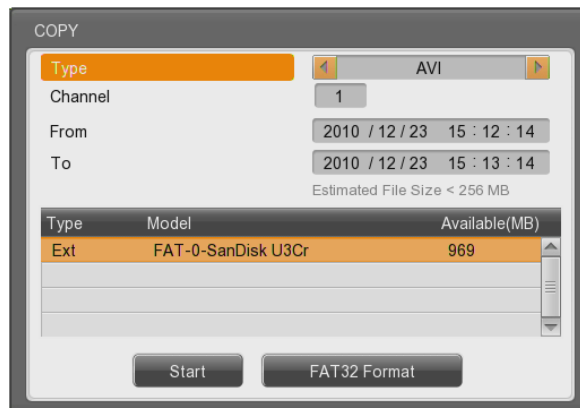
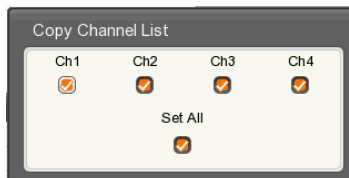

[AVI Copy]

<Reference>

A USB Flash memory which should install additional program on Windows OS, cannot be recognized.

**2.3.3.6 Video In/Out connection**

DVR receives HD-SDI Video signal (SMPTE 292M). The resolution of Video input signal will be selected automatically.

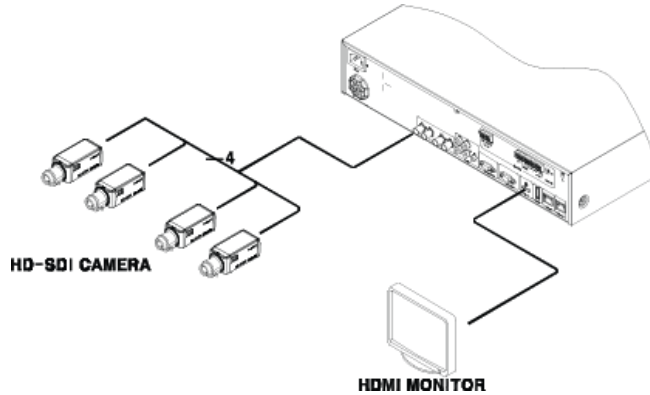

**2.3.3.7 Audio In/Out connection**

There are 4 RCA Audio Input and 1 RCA output.

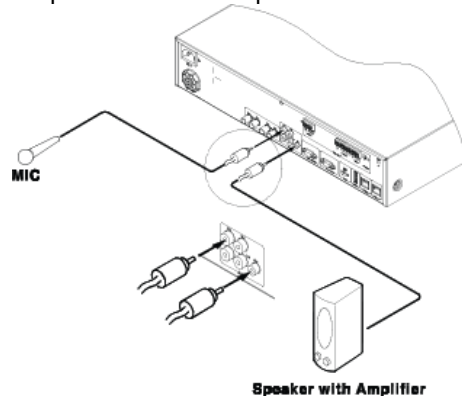

**2.3.4 HDD**

※ Please, ask to distributor or manufacturer for available HDD list.

**2.3.4.1 HDD registration and format**

After mounting HDD and booting system, "Disk Manager" will execute automatically. If not, please, check the connectivity of HDD

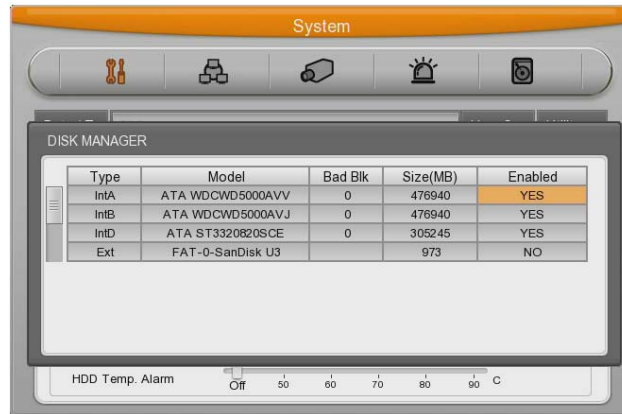

- (1) Press [Enter] button in “Disk Manager”
- (2) Using [▲/▼] Key, select new HDD(Displayed [No] on Enabled item) and press [Enter].
- (3) If you see the message for format, select [Yes].
- (4) Press [ESC] and escape from “Disk Manager”.

### 2.3.4.2 HDD Replacement

- (1) Turn Off the DVR and take off the HDD that has a problem and replace it with new HDD.
- (2) Turn On the DVR and go to “Disk Manager” menu and select the removed HDD which has a problem, and press “Enter” Key.
- (3) “Removed disk will be Confirmed” message will be pop-up and select “Yes” to delete it from the list.
- (4) Select the new HDD from the list and press “Enter” key.
- (5) Select “Yes” when the system asking “do you want to format”
- (6) After complete above procedure then Press “ESC” key to exit the “Disk Manager” menu.

#### <Note>

##### 1. HDD Re-using (Add Used)

You can use HDD that has been used before from DVR, in this case you do not need to do format and delete the data.

How to use it? Please install previous HDD in the DVR, and go to “Disk Manager” menu and select the HDD that you wish to re-use which is you just installed HDD, and press “Enter” key then you will see the pop-up message “This disk can be added without format/Nevertheless, do you want format this disk?” and select “NO” for re-use without format, and select “YES” for format.

### 2.3.5 Remote monitor and control

Via Internet/Intranet, in remote site, user can access with PC.



### 2.3.5.1 Ethernet connectio

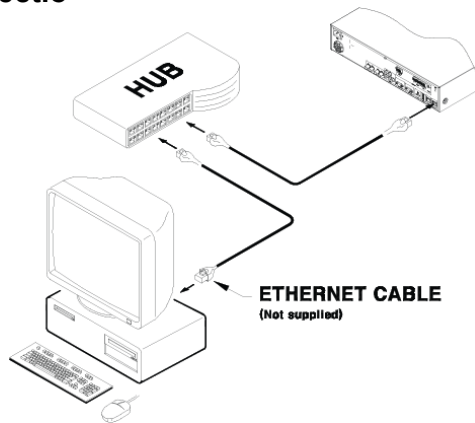

- (1) Cut power
- (2) Connect Ethernet cable to DVR and Hub.
- (3) Input Power.

#### <Reference>

To protect DVR damage, after connecting Ethernet cable, input Power. Please, check Ethernet cable connection firmly. Input power on DVR and check their connectivity.

### 2.3.5.2 Network Configuration.



#### Ethernet

Set type as Ethernet and input IP, Netmask, Gateway, DNS. The way to input is using directional key or mouse wheel.

#### PPPoE

Set type xDSL, and move to xDSL menu. First, change Ethernet Port Please, input ID and Password for PPPoE.



### WRS

After changing interval over 1 min, register WRS address and product and input Group ID.

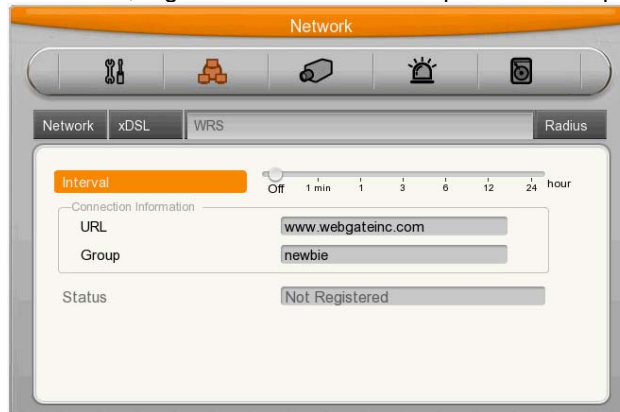

## 2.3.6 External device connection

DVR has external Storage Device Interface and 1 ea of eSATA port. Using eSATA port, user can expand Storage capacity up to 8TB.

**<Note>**

Since some of eSATA device cannot be compatible with DVR, before the usage, please, contact the seller and check its compatibility in advance.

### 2.3.6.1 eSATA Device Connection

In case of external eSATA supporting FireWire, using eSATA port on the rear part. And since DVR does not support power to eSATA, eSATA device should be one external power is supported.

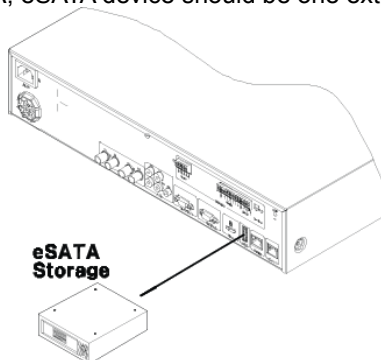

**<Note>**

Basically eSATA is connected to DVR while DVR is running, works properly. However it depends on eSATA manufacturer. Therefore, we recommend below order for making connection.

- A. Power off DVR
- B. Connect external eSATA storage with power-off
- C. Power on DVR
- D. Power on external device after completion of DVR booting,

## **2.3.7 NVS04 connection**

### **2.3.7.1 Connecting with DVR**

- (1) Connect to DVR as shown in the picture below using Gigabit Ethernet Cable.
- (2) Connect DVR Port of NVS04R and Storage Port of DVR directly.

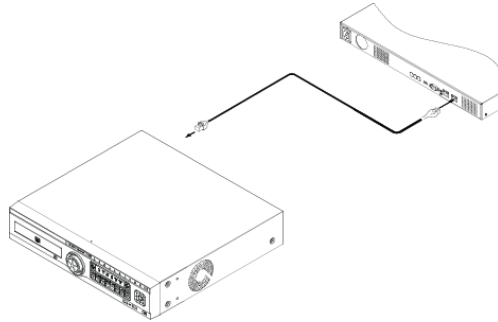

**<Note>**

1) The network cable connected to DVR should be Gigabit Ethernet Cable (Category-6). If not, it is not connected to DVR.

### 2.3.7.2 Set ID Configuration

Set ID using Rotary Switch located on the back. This ID is used as IP Address of NVS04R and the form of IP address is 10.10.20.XXX. When the user connect more than 2 units of NVS04R, each ID should be set differently.

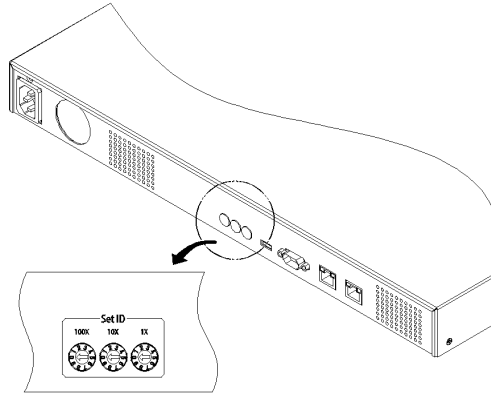

Set the ID using driver. The value for the first digit of switch should match with values of 100x on the rare panel while the second digit of switch should match with value of 10x and the third digit of switch should match with 1x on the rare panel

### 2.3.7.3 Power connection and operation

- (1) Connect power as below.
- (2) As soon as power is connected, the device starts booting

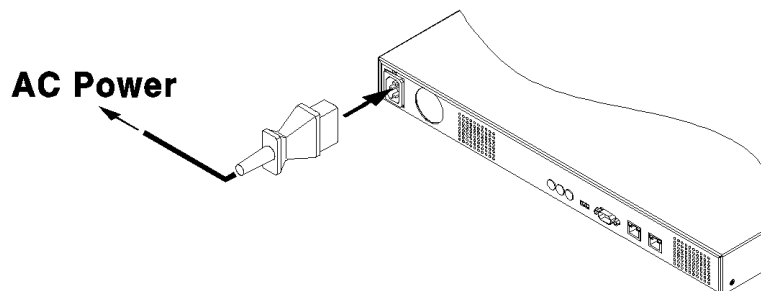

#### <Note>

- 1) It takes around 1 minute to connect NVS04R and DVR after connecting power. Four LEDs at the front starts blinking and they are fully on when connection is completed. The HDD list is available to check at Disk Manager
- 2) User needs to install firmware for NVS04 separately. Please refer to **"NVS04 installation & user guide"** for details.

# User Manual

## 3.Menu Usage

### 3.1 Menu Structure

The menu structure will be shown like below image, and each menu setting method described from chapter 4 to chapter 6.

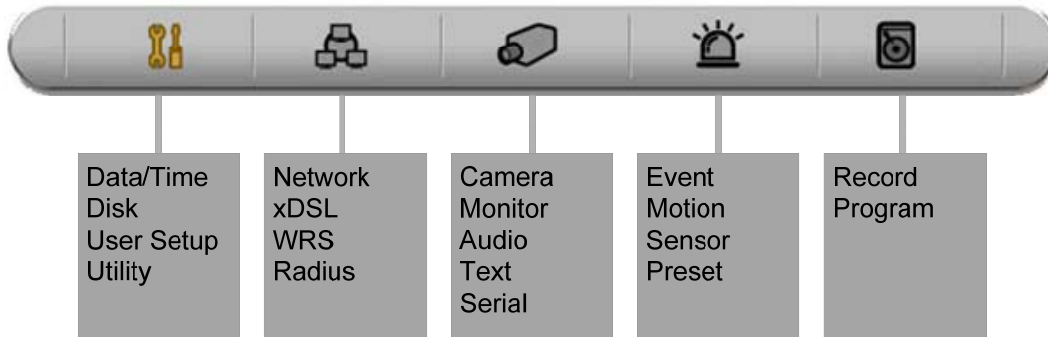

### 3.2 Function Menu

To run Function menu, please, click the right button of mouse in live monitoring or playback status or push "Func" button on the front panel.

The Function menu can be controlled by mouse.

Each function can be executed by clicking right button of mouse and click desired icon.

The Function menu also can be controlled by front part of DVR's buttons.

Please refer to below picture for the Function menu structure.

#### Function menu in live screen

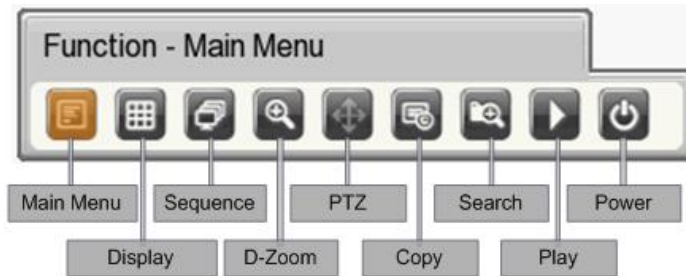

#### Function menu in playback screen

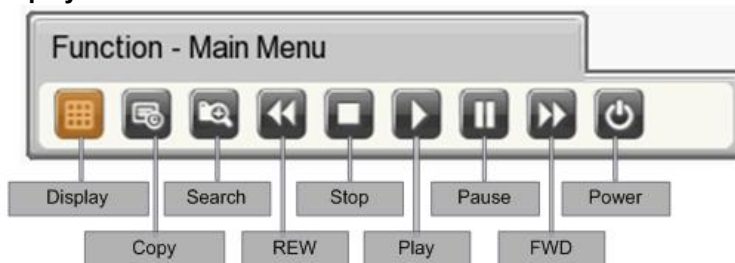

### 3.3 Factory Reset

In order to reset value to factory value, go to System Setting->System->Setting, and once press Factory Reset then the warning message will be appear, click "Yes" to reset the DVR value to factory.

**Default Value from Factory**

<b>System</b>				
Date Time	Time Zone		UTC 00:00 Dublin	
	Daylight Saving		Off	
	NTP Function	Sync With NTP		Off
		NTP Mode		Client
		NTP Server Loc.		Public
		NTP Local Server IP		0.0.0.0
		Interval		1(hour)
		Date Format		MM/DD/YYYY
	Time		Current Time	
Disk	Over Write(Auto Deletion)		On	
	Disk Full Alarm Warning		55	
	Block Playback		0	
	Block Recording		Off	
	Disk Manager		>>	
	Disk Status		>>	
	Disk Mirroring		Off	
	Disk Replace		>>	
	HDD Temp Alarm		Off	
User Setup			Check : X	
Utility	DVR Alias		DVR0	
	Language		English	
	DVR Keyboard ID		1	
	Remote Controller ID		All	
	Firmware Update		>>	
	System Log		>>	
	Factory Reset		>>	
	Config Import/Export		>>	
	System Information		>>	
<b>Network</b>				
Network	Type		Ethernet	
	DHCP		Off	
	IP addr		Current IP	
	Net Mask		Current Net Mask	
	Gateway		Current Gateway	
	UPnP Port Forwarding		>>	
	DNS Server		>>	
	Port		80	

**Install&User's Guide**

	Network Stream	Ch1	CIF, 30ips, Q5	
		Ch2	CIF, 30ips, Q5	
		Ch3	CIF, 30ips, Q5	
		Ch4	CIF, 30ips, Q5	
	Band Width Limit(Mbps)		0.0	
xDSL	User ID		Guest	
	Password		*****	
	Status		xDSL not connected	
WRS	Interval		Off	
	URL		www.webgateinc.com	
	Group		Newbie	
	Status		Not Registered	
Radius	Status		Disable	
	IP Address		0.0.0.0	
	Port		1812	
<b>Device</b>				
Camera	Camera Number		Ch1	
	Status		On	
	Name		Cam 1	
	Input Resolution		Current Resolution	
	Encoding Resolution		720p	
	PTZ	PTZ Home		Off
		PTZ Idle Time		5
		PTZ Port		None
PTZ Address			0	
Monitor	Monitor			
	Alarm Pop-up(Sec)		Off	
	Multi Mode		4C. >>	
	Covert		>>	
	Info Level		>>	
	Sequence Configuration		>>	
Audio	Audio Channel		1	
	Audio Recording		Off	
	Sync Video Channel		Ch1	
	Audio Gain		0	
	Audio Mix		Mix On	
Text	Recording		Off	
	Sync Test With		Ch1	
	Device		Manual	
	Seek Header		Off	
	Header 1		Header1	
	Header 2		Header2	
	Delimiter		0D0A	
	Timeout(ms)		1000	

	Lines		20
Serial	Serial Port		Com1
	Device		None
	Interface		RS232
	Baud Rate		9600
	Parity Bit		None
	Stop Bit		1
	Data Bit		8
<b>Event</b>			
Event	Event Check		Always
	Event Action		Relay1
	Action Duration		10 Sec
	Normal Event Source		>>
	System Event Source		>>
Motion	MD		All
	Sensitivity		5
	Area		Set All
Sensor	Sensor		All, N.O.
Preset	Channel Number		Ch1
	Preset		Sensor1, Preset1
<b>Record</b>			
Record	Record Mode		Manual & Event
	Program		ProgramA
	Pre Event Duration		1
	Post Event Duration		1
Program	Normal	Input Res	720p30
		Rec. Res	720p
		Frame Rate	All 15
		Quality	All Q5
	Event	Input Res	720p30
		Rec. Res	720p
		Frame Rate	All 15
		Quality	All Q5

**Initialization setting value of program**

Rec. Mode	Normal			Event			
항목	Rec. Res	Fps	Q	Rec. Res	Fps	Q	
Program	A	1080p/720p	15	Q5	1080p/720p	15	Q5
	B	1080p/720p	7	Q5	1080p/720p	7	Q5
	C	1080p/720p	4	Q5	1080p/720p	4	Q5
	D	1080p/720p	15	Q4	1080p/720p	15	Q4
	E	1080p/720p	7	Q4	1080p/720p	7	Q4
	F	1080p/720p	4	Q4	1080p/720p	4	Q4
	G	1080p/720p	15	Q3	1080p/720p	15	Q3



## Install&User's Guide

---

H	1080p/720p	7	Q3	1080p/720p	7	Q3
I	1080p/720p	4	Q3	1080p/720p	4	Q3

## 4. Monitoring

All analog video image channels connected to DVR is displayed to screen by Power connection. It is to utilize all monitoring mode of DVR.

### 4.1 Basic Screen

After Power connection, the DVR operates on automate.  
It boots with LED on.

### 4.2 Single Full Screen Mode

After press the channel number wanted or click mouse button.  
Press [MULTI] button to return to divisional screen

### 4.3 Multi Screen Mode

Press [MULTI] for multi-channel display or click "Display" icon from Function menu .



### 4.4 Screen Description

The status bar from monitoring screen, it shows DVR's current status that included Date/Time, Record, Motion/Sensor Detection, Manual Record, Text input and HDD's record capacity.

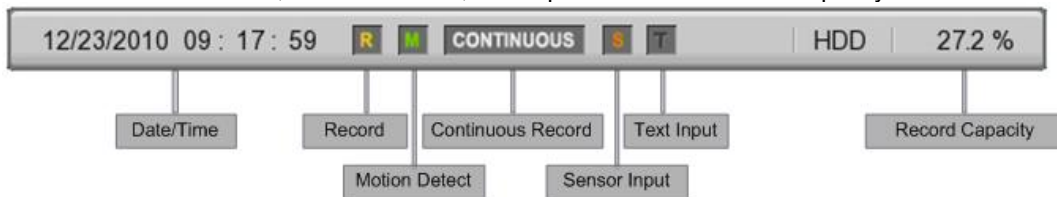

### 4.5 Auto Switch Mode (Sequence)

Defined channels or multi screens can be displayed in sequence with configured time interval. Maximum 4 channels or multi screens can be defined.

#### 4.5.1 System Standard Mode

By [SEQ] button, it can monitor auto switching of defined channels.

Press [MENU] for the setting switching term or using mouse click menu icon from function menu.

Move to "Device" → "Monitor" from OSD menu.

Select "Monitor" under 'Device" with [Enter] button or mouse click. Set value from 1 sec. to 60 sec.

At OFF set, auto switch mode does not operate



Auto Switch mode can be set in every division mode by the press [SEQ] button. Press [SEQ] button once more to leave from Auto Switch mode.

#### 4.5.2 User Sequence Mode

[Press [AUTO] button or click [Sequence] icon from Function menu with mouse.

- Auto Switch model can be set from "Monitor" main menu.

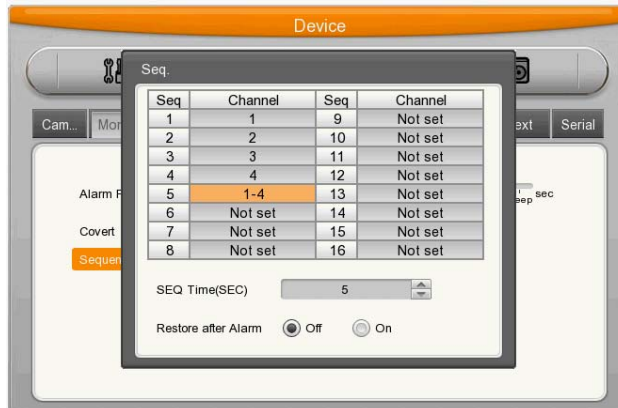

#### 4.6 Event Screen

When the event is occurred, the green color [M] and red color [S] will be display from status bar. In case of [M] displayed, the camera name will be turned to green color, and it will turn to yellow when Motion Detection event finish.

In case of [S] displayed, the camera name will be turned to red color, and it will turn to yellow when Sensor event finish

It can be set to Pop-up automatically relevant screen when alarming.

Set pop-up period can be set into "Alarm Pop-up (sec)" inferior to "Monitor" menu.

At the simultaneous alarming in several channels, it displays the division as many channel as alarmed. For example, when 3 channels alarm, 4 divisions is displayed on screen. And press any button to return original channel.



If Alarm pop-up set to Off, Event pop-up is not activated

If Alarm pop-up set to Keep, it keeps showing pop-up image until user press any button. To return to previous screen, please press any button.

#### 4.7 Zoom Screen Mode



- From single full screen mode, press [FUNC] and D-Zoom button then select + button to activate zooming the image.
- Default zoom screen locates to main center when press [ZOOM] button. Zoom image can shift left-right in 22 steps and top-bottom in 15 steps.
- Use directional key(up/down/left/right) button to screen move.
- Press [-] one more with [Enter] or mouse click to return to original screen.

#### 4.8 Pause Live Screen

- Live screen can pause like PlayBack.
- Press II(PAUSE) to pause live screen and press II(PAUSE) to return live screen.

## 4.9 PTZ Control

Connect PTZ controller to DVR and set relevant protocol from "Serial" menu, then PTZ can operate while monitoring live images.

To operate PTZ, change the screen to relevant single mode which is connected with PTZ. Then PTZ works automatically with following icon.

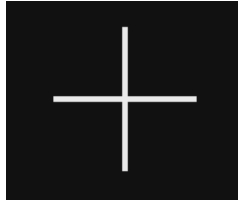

PAN/TILT can be used with directional button on front panel, and PAN/TILT/ZOOM can be used with mouse.

Press PTZ button from DVR's front panel, or click PTZ icon from Function menu to use OSD Menu, Focus, Preset, Aux.



### PTZ supportable protocol

Model	Manufacturer
BOSCH AutoDome, TC8560X-4	Bosch
PELCO(P), PELCO(D)	Pelco
Sony EVI-D3x	Sony
VT VPT-4x	VT
AD SpeedDome	AD
SungJin SJ372R1	SungJin
Samsung SCC641	Samsung Electric
Panasonic WV-CS850	Panasonic
SDZ160/330, Samsung SPD, Keyboard SCC3000A, Samsung SRX-100B	Samsung Techwin
LG GAC-PT2	LG
Keyboard KBD300A, WGI SPD1800/2600	Honeywell
WKC-100	Honeywell
Merit-Lilin FastDome	Merit
Elmo PTC200C	Elmo
Canon VC-C4	Canon
HTC-230S	DongYang Unitech

RVision	RVision
Elbex	Elbex
Honeywell 755/655, HRX-2000, HTX-3000, ScanDome2	Honeywell
VIDO	VIDO
VICON	Vicon
Hunt	Hunt
ORX-1000	Sysmenia
Fine CRR-1600	LiveEye
Tokina	Tokina
Kodicom KRE	Kodicom
Nuvico	Nuvico

#### 4.9.1 Pan/Tilt/Zoom

This menu is used to control Pan / Tilt / Zoom function.  
 Select relevant channel to control PTZ which is connected with PTZ.

#### 4.9.2 Focus

Press [PTZ] button in PTZ screen to activate Focus menu.  
 Control focus with [Near] or [Far] buttons .

#### 4.9.3 Load Preset

Press [PTZ] button in PTZ screen to activate Load Preset menu.  
 Select Preset number wanted and press [Load] button

#### 4.9.4 Save Preset

Press [PTZ] button in PTZ screen to activate Save Preset menu.  
 Select Preset number when you want to save and press [Save] button

#### 4.9.5 Auxiliary On

Press [PTZ] button in PTZ screen to activate Aux On menu.

- Using up / down button or mouse wheel to select the Aux Number.
- Select On and press Enter button or click from mouse.  
 (Aux function is available to max 16 functions.)

#### 4.9.6 Auxiliary Off

Press [PTZ] button in PTZ screen to activate Aux Off menu.

- Using up / down button or mouse wheel to select the Aux Number.
- Select Off and press Enter button or click from mouse.

#### 4.9.7 Menu

It is to go into connected PTZ's menu, using up/down/left/right and enter key from front panel for setting the menu, and press ESC button for exit the menu.

## 5. Playback

### 5.1 Playback Mode

#### 5.1.1 Playback on Standard monitor

- Please, push play button in monitoring mode or mouse click play button in Function menu.
- If pushing Play button or FWD button, video playbacks in forward direction at 1× speed.
- If pushing REW button, video playbacks in reverse direction at 1× speed.
- If pushing Playback button in multi-division monitor mode recorded image in 4ch division will be played.

#### 5.1.2 Playback function

- ◀▶ : Playback 1× speed. If using mouse, click Play button in Function menu.  
Multi channel video will play back if pushing [PLAY] button in monitor mode. And it playbacks from the latest played back. If pressing this button one more during playback, playback direction is reversed.
- || : Pause playback temporary. With mouse, click Pause button in Function menu.
- : Stop playback. With mouse, click Stop button in Function menu.
- ▶▶ : Playback speed will be changed. (x1, x2, x4, x8, x16, x32, x64, x1/2, x1, x2, x4 – in order), If pushing [FWD] button in live view, it plays back video 1 minute ago. Playback speed can be changed by pushing [FWD] button or clicking [FWD] button in Function menu.
- ◀◀ : Reverse playback speed will be changed. (x1, x2, x4, x8, x16, x32, x64, x1/2, x1, x2, x4 in order)  
If pushing [REW] button in live view, it plays back video 1 minute ago. Playback speed can be changed by pushing [REW] button or clicking [REW] button in Function menu
- |▶ : If pushing [FWD] button on Pause mode, playback by each frame to the forward. Push [PLAY] to return normal playback.
- ◀| : If pushing [REW] button on Pause mode, playback by each frame to the reverse. Push [PLAY] to return normal playback.
- Jog/Shuttle : changeable to various playback speeds (x1, x2, x4, x8, x16, x32, x64, x1/2) with either playback direction in playback status.

### 5.2 SEARCH MODE

This menu is to playback specific time data from the time frame and searching log at Playback mode. There are Time, Calendar, Event, Thumbnail mode.  
Please, push Search button on the front panel or click in Function menu.

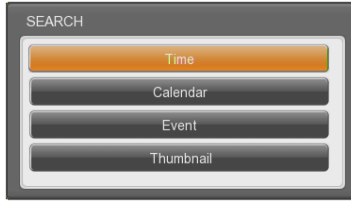

### 5.2.1 Time Search

Select date and time to search and playback video will be moved to the selected point.

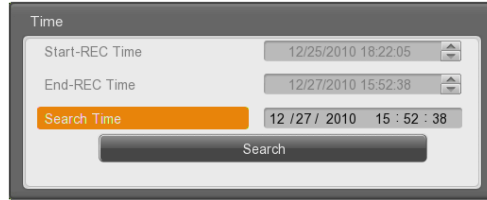

- Start-REC Time** : The date and time of start-recording
- End-REC Time** : The latest date and time of the recording
- Search Time** : Select the range of date and time for Search
- Search** : Execution button

### 5.2.2 Schedule Search

Calendar based search will enable user to search easily.

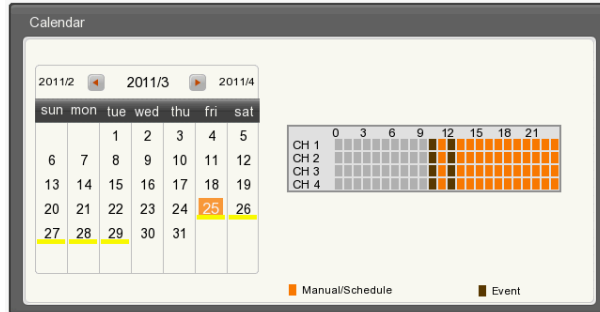

Display recording status of channel 1~4ch

- Year** : Select Year to search. With mouse wheel, user can change it.
- Month** : Select Month to search. With mouse wheel, user can change it.
- Date** : Select Date to search. With mouse, select the date and decide the time by wheel.
- Time** : Select the time and push Enter button to playback.

### 5.2.3 Event Search

User can search by all channels, some of channels, all events, motion detection, sensor in certain range. For change of date and time, with front panel, please use top and down button. In case of using mouse, scroll the mouse wheel after selecting area. Searched result will be displayed on additional event window. Select and push enter or scroll the mouse wheel to move to the wanted date and time area.



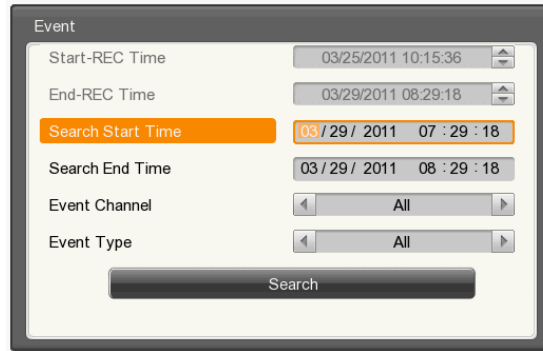

- Start-REC Time** : Starting date and time of the recording.
- End-REC Time** : The latest date and time of the recording
- Search Start Time** : Input start date and time for search with direction button and push Enter and change the value by Up and Down button. With mouse, click and scroll the wheel.
- Search end Time** : Input end date and time for search with direction button and push Enter and change the value by Up and Down button. With mouse, click and scroll the wheel.
- Event Channel** : Select the channel for search  
1 ~ 4ch(8ch) can be selectable.
- Event Type** : Select the event type for search  
There are all events, motion detection, sensor, video loss, text type

After event search, following result is displayed  
Select one of them to playback the relevant recorded data.

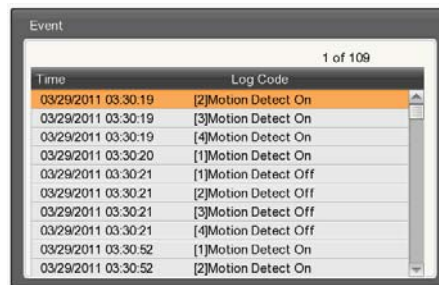

### 5.2.4 Thumbnail Search

Search certain channel by thumbnail type. If select the searched thumbnail, selected date and time video will be played back.



- Channel** : Select the channel and change the value by direction key or mouse wheel.
- Start Time** : Input the date and time for starting search and change the value using up-down direction key or mouse wheel.
- Interval** : Set Interval value by Up-down button or mouse wheel.
- View video** : If pushing search button, 16 cycles will be shown based on start time. Press [Func] to return to the search or use mouse wheel.

**Select video** : Play back from the selected video of thumbnail search result.  
With pressing Enter or clicking mouse, use can play back.

After Thumbnail search, following result is displayed  
Select one of them to playback the relevant recorded data



### 5.3 Copy

This is for copying recorded video. There are CD/DVD and RE4 and AVI type.  
Copy function is supported to be used by user who has the authorization. For authority configuration,  
please, refer to **6.2.3 User setup**

To use copy function, press [COPY] or Click Copy button in Function menu.

#### 5.3.1 CD/DVD

This is copy function by using CD or DVD. CD or DVD will be automatically searched.

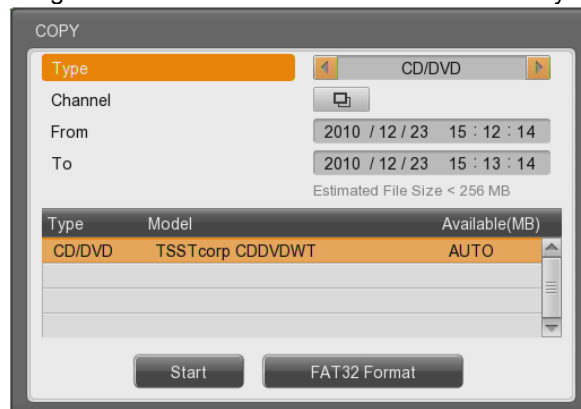

**Type** : Select CD/DVD using up-down direction key or mouse wheel. Press Enter and scroll wheel to change the value.

**Channel** : User can select some or all channel among 4 channels. Select the channel location and press Enter or use mouse wheel.

**From** : Select start date and time to copy using up-down key or mouse wheel.

**To** : Select end date and time to copy using up-down key or mouse wheel.

**Select Disk** : Select the media to copy using Enter button on Select Disk.

- Start** : Start Copy. Press Start button with Enter or click the left button of the mouse.
- FAT32 format** : Format USB memory or HDD by FAT32 type.  
Do not use when copying into CD/DVD. First execute format and select FAT32 button and press Enter or click left mouse button.
- Estimated File Size** : Display file size of recorded data which is selected.

Please, refer to the recommended media list below.

DVD-R manufacturer	CD-R Manufacturer
Mitsubishi(×16 recommended)	Mitsubishi(×52 recommended)
TDK(×16 recommended)	TDK(×52 recommended)
Imation(×16 recommended)	Imation(×52 recommended)
Sony(×16 recommended)	Sony(×48 recommended)

### 5.3.2 RE4

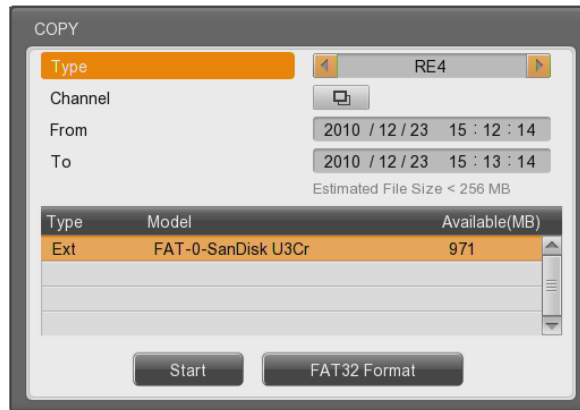

User can back up by HDD, USB memory and play back using mini-player or Control Center.  
Select channel position and press Enter or use mouse wheel to open the channel list like below

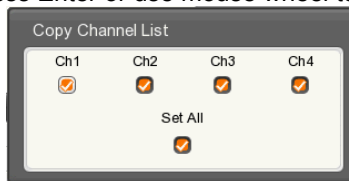

- Type** : Select RE4 using up-down button or mouse wheel.
- Channel** : To pop up the channel selection window, press Enter or use mouse wheel.
- Select Channel** : use can select some or all channels and after selecting channel, press Enter or click mouse left button.
- Start time** : Set start date or time to copy. After selecting part for change and set the value using up-down key or mouse wheel.
- End time** : Set End date or time to copy. After selecting part for change and set the value using up-down key or mouse wheel.
- Select disk** : Select media to copy. Press Enter on Disk list or click mouse.
- Start** : Start copy. Press Enter or click mouse.
- FAT32 format** : If USB memory or HDD are not formatted, format by FAT32 first and copy. To execute, press Enter or click mouse.

**Caution: not perfectly finished backup file will not be played back in PC.**

### 5.3.3 AVI

6 Use USB memory or HDD to copy certain part.

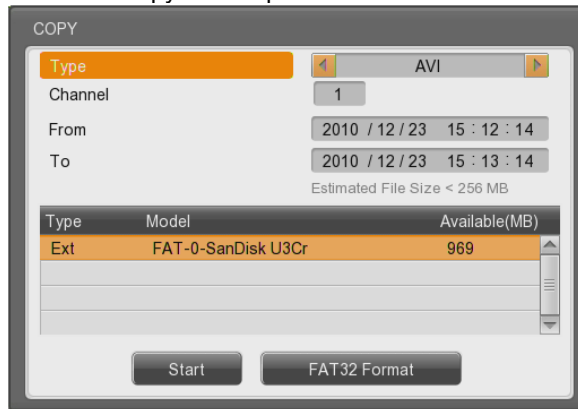

**Type**  
**Channel**  
**From**

: Select AVI using up-down key or mouse wheel.  
 : Select the channel to copy by up-down key or mouse wheel.  
 : Set start date and time to copy. Time and Year by left/right button and date/time by up/down button. With mouse, click left button first and use wheel.

**Duration**

: Set copy length. Copy as selected time length from the start using up/down key or mouse wheel.

**Select disk**

: Select media to copy. Press Enter and select media or click mouse.

**Start**

: Start copy. Press Enter or click mouse.

**FAT32 Format**

: Format USB Memory or HDD not formatted.

**Caution** : If copied file is not played back, please, install integrated codec first

## 6. Configuration

### 6.1 Recording Structure

There are 3 modes in DVR recording. Configuration relation structure is like below. Please, refer to the below each item for detailed recording configuration.

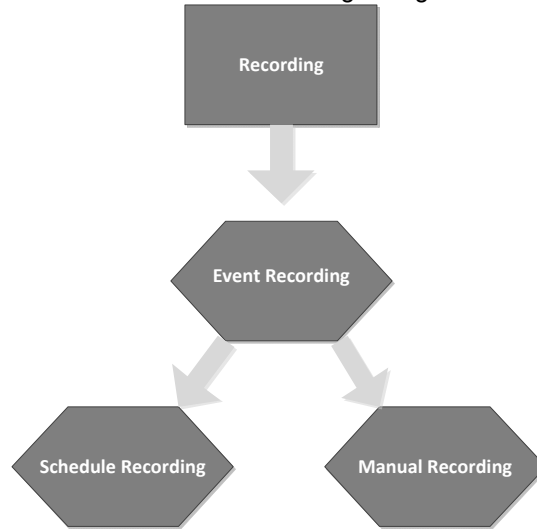

### 6.2 System Setup

Time and Disk and authority can be configured.

#### 6.2.1 Date/Time

Time set should be configured prior to the recording.



Time configuration is very important to protect the recording data. Time change on recording is not recommended. Time zone configuration value of factory default is "UTC 00:00 Dublin"

#### 6.2.1.1 Time Setup

**Caution:** under recording, if user changes Time, it will affect time change on previously Recorded video data in accordance with. Therefore, we recommend backup before time change.

- Press Main Menu of Function or [MENU] button on the front panel.
- Move to "Date/Time" menu.
- After selecting "Date/Time" in Quick setup and press [Enter] or click.
- Menu of time configuration 6.2 will be opened
- To move to the sub menu, use directional key or mouse.

### Time zone

Use left/right direction key or mouse wheel. To return to previous menu, press [ESC] or click right mouse button. (It is same as OSD menu)

### Daylight saving

This menu is synchronized with time zone configuration menu. It means when daylight saving area is set, this function works. Daylight saving applicable area is all the same with Time zone of Microsoft Windows.

### Date format

With using left/right direction key or mouse wheel, configure date among "MM/DD/YYYY", "YYYY/MM/DD", "DD/MM/YYYY".

### Time

With left/right direction key, use can move to year, month, day, hour in order and each configuration will be controlled by up/down key or mouse wheel.

### Apply

User must push "Apple Date/Time" button. And you will see the below message box.



### <Caution>

Except date/time configuration, other configuration records automatically, but "date/time" configuration influences critical effect to HDD recording file system, It doesn't record automatically. To apply the changed value, user must press [Apply] button.

### 6.2.1.2 NTP Setup

NTP(Network Time Protocol) make time of connected devices synchronized. There are NTP server and client which get time signal from the server.



**Sync NTP**  
**Set NTP function on/off.**

**NTP Mode**  
Configure NTP mode of DVR – Client / Server / All

**NTP Server Loc.**  
When NTP mode is client, it is on Enable. Configure yes or no wither NTP server is in Local Network or Public.

**NTP Local server IP**  
In NTP local server Enable, configure server ip. Input IP address of NTP server or DVR set by NTP server in local network.

**Interval**  
Configure interval of time sync.

**Caution: If use NTP client mode, user must set NTP on.**

**6.2.2 Disk**

It explains how to add or remove or format internal or external HDD.



**Over Write(Auto Deletion)**  
If there is no space in HDD, old data will be deleted automatically.

**Disk Full Alarm Warning**  
It gives notice if the recorded data is full up to configured limitation of all HDD disks which is connected to DVR.

### Block Playback

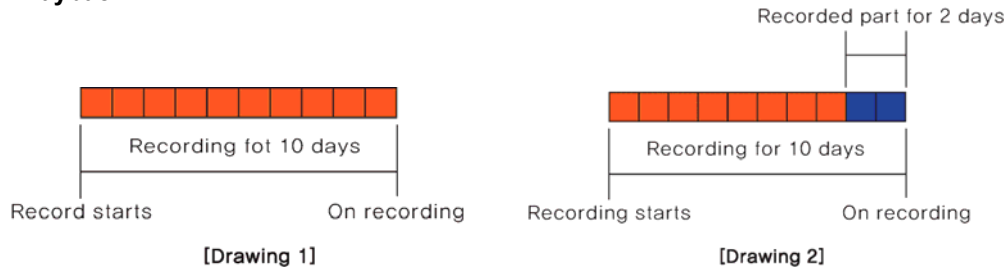

This function makes recording data seen during the limited area.

For instance, if setting block playback by 2 day(Pic 2) among 10 days, just allowed 2 days data can be played back.

### Block Recording

This option is to record only the date you selected.

For example, if you select 3 days then DVR will record up to 3 days, and keep overwriting 3 days period of data

#### 6.2.2.1 Disk Manager

This is menu for the management of internal or external HDD.

Manage status, bad block, size, Yes or No etc.



- Type** : display location or type of disk.  
Int A (Internal A HDD), Int B (Internal B HDD), Ext (External HDD)
- Model** : HDD model name.
- Bad Blk** : display bad block. In HDD. If no problem, "0" will be displayed. Others are Not shown anything at all.
- Size** : Display HDD size by MB unit
- Enabled** : Make HDD enable mode or disable mode.  
Yes: enable / No: Disable

#### In case HDD YES

- **Enabled** : Press [Enter] in No mode or scroll mouse wheel. Notice window pops up and show user the message like below.
- Caution : This Disk is not available without format. Will you format Disk?
- If selecting **No**, keep previous data and HDD will be Enable to use.
- If selecting Yes, delete previous data and HDD will be Enable to use.



### In case HDD No

- **Enabled** : In Yes mode, press [Enter] or scroll mouse wheel and notice window pops up and show user the message like below.
- Caution, will you remove Disk?
- **If Yes, user will find the message “Disk is removed” on the bottom and Enable status will be No.**
- HDD is not used.

### 6.2.2.2 Disk Status

Temperature and status of HDD will be shown.

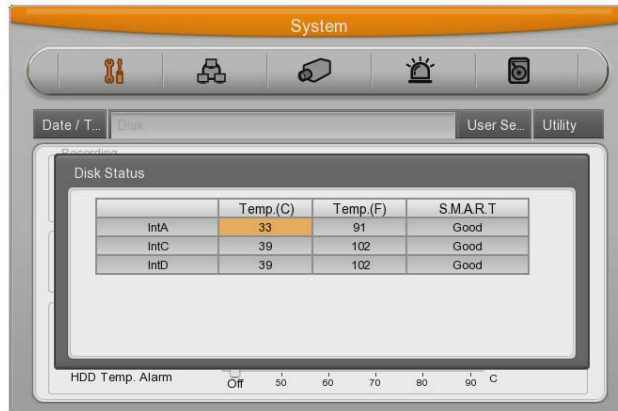

### 6.2.2.3 Disk Mirroring

This DVR has DVR Mirroring function in itself and NVS Mirroring on NVS(Network Video Storage) via Gigabit Network <sup>[1]</sup>

Without additional user control, if connecting DVR and NVS via Gigabit Network Cable, Mirroring function will be activated and user can operate it easily and simply.

But, when using Mirroring function, DVR system performance will be down and recording configuration will be automatically adjusted.

Recorded Video data via Mirroring function can playback in another DVR. But if user wants to use the HDD for recording, it should be formatted again.

- File system supporting Max. 32TB
- Support max 8 ea of NVS via Cascade Network Port.
- Support Local(DVR) 2 bay / NVS 4 bay SATA Hot Swap Bay
- Support Local(DVR) Recording 8TB (4TB with Mirroring)
- NVS recording 32TB (Mirroring 16TB) will be supported soon.

### DVR Mirroring working method

---

<sup>[1]</sup> Category 6

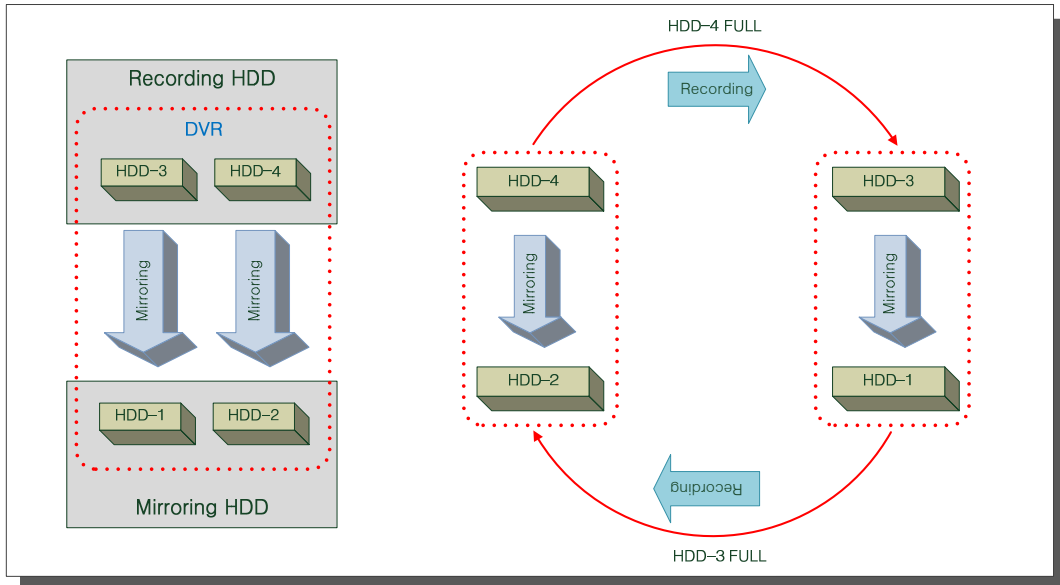

- (1) Basically HDDs will be set like the above.
- (2) Recording data of HDD-3 is mirroring with HDD-1 and recording data of HDD-4 is mirroring to HDD-2.
- (3) If there are 4 ea of HDDs are mounted on DVR and starts recording, HDD-4 will start recording.
- (4) If HDD-4 is full, automatically HDD-3 will start recording.
- (5) In case that Disk Auto Deletion is configured, when HDD-3 is full, automatically system return to HDD-4 and it will overwrite from the oldest data for recording.
- (6) To check Mirroring recording data, it will be possible on the additional DVR. Removed
- (7) Mirroring HDD should be used only for keeping or Playback. And if user wants to reuse Mirroring HDD for recording, it should be formatted.

**Mirroring configuration**

- Off : All mounted HDD will be recorded in order without Mirroring.
- DVR : Mirroring recording only with internally mounted HDD ( not HDD in NVS04R)
- NVS : Mirroring recording only with HDD in NVS04R which is connected to DVR. (not HDD in DVR)
- All : Mirroring recording with all HDDs in DVR and NVS04R.



- (1) Using directional key in Disk Mirroring configuration, please, select DVR for use and press Enter. But, before Mirroring configuration, all HDDs should be Removed – (Remove (NO)).
- (2) After configuration with Enter, if Pop-up message window is shown, select YES.
- (3) After moving to Disk Manager, all mounted HDDs are supposed to be formatted and IntA,B is configured as [M](Mirroring) and IntC,D maintains [NO] status.
- (4) After selecting Int C,D and then Add(YES), select YES on Pop-up window and press Enter.
- (5) Configured HDD is shifted from [NO] to [YES] and DVR can use the HDD for recording.
- (6) After all configurations for Mirroring, if it works properly, HDD for recording and HDD for Mirroring LED of the front panel will be blink. If not recording, front LED will off



<Note>

1. For Mirroring function, HDDs capacity and model for Recording and Mirroring should be same. If not, it won't work.  
 But, in case that HDD capacity is same but just different model, sometimes, it cannot work properly.

Ex) Example for normal Mirroring and abnormal Mirroring

1) Normal Mirroring case

Type	Model	Bad Blk	Size(MB)	Enabled
IntA	ATA WDCWD5000AV	0	476940	No
IntB	ATA ST3250820AS	0	238475	No
IntC	TA WDCWD5000AV	0	476940	No
IntD	ATA ST3250820AS	0	238475	No

2) Abnormal Mirroring case or not recommended.(different model and size)

Type	Model	Bad Blk	Size(MB)	Enabled
IntA	ATA WDCWD5000AV	0	476940	No
IntB	ATA ST3250820AS	0	238475	No
IntC	ATA ST3250820AS	0	476940	No
IntD	ATA ST3250820AS	0	479640	No

2. For Mirroring configuration, HDD status of all HDDs in existing DVR and NVS04R should be [NO].

If, one of HDDs is not [NO] status, since Mirroring configuration will be failed, please, remove HDD and make all HDDs at [NO] status.

But, except HDDs formatted by FAT32 from CD/DVD or external storage (eSATA, IEEE1394, USB).

3. For Mirroring configuration in NVS04R or DVR, other HDDs should not be added except its Mirroring configuration.

Ex) For NVS04R Mirroring configuration, all HDDs in DVR should be [NO] status.

### Recording Configuration.

When using Mirroring function, according to configuration option, DVR system performance will be down and due to this reason, recording configuration Will be adjusted automatically like below table chart.

### 6.2.2.4 Mirroring HDD replacement.

If Mirroring HDD free space becomes 0%, on DVR console screen, alarm pop-up message will be shown for Mirroring HDD replacement. This time, user can check Mirroring HDD free space in Disk Replace menu and user can replace it.



Loc : Mirroring HDD name

Free : HDD free space

From : Date and time of Start recording.

To : Date and time of End recording

State : If free space is enough, it is displayed by Mirroring and if 0%, displayed by Replace. With these information, user can notice the HDD replacement timing.

**<Note>**

1. For Mirroring HDD replacement, user must do it in HDD Change menu.
2. This time, HDD for replacement should be same model and capacity with the original HDD.
3. If user does not replace Mirroring HDD after replacement popup message – 0%, System will delete the oldest data in sequence and keep Mirroring.  
This time, if user check Mirroring block of each HDD in HDD replace menu, user can see the doubled block but it just points out that this Mirroring HDD is not replaced.  
Actual recording data is not doubled

**6.2.3 User Setup**

There is administrator and user and administrator can use all functions. The max. Number of user is 10 person. Each user can use the function allowed.

**Check**

If Check item is configured all by X[Check-1], all users can use all functions



[검사-1]

[검사-2]

In the other hand, if all are set by O[check-2], all users can use the functions in accordance with Each users authority.

For example, as you can see the below picture, User1 can use PTZ, Relay off, power On, N/mike functions are available, user 2 just can use menu and N/mike functions.



**<Reference>**

Admin Password is “12345” in factory default and from user 1 to 10 in order “11111”, ”22222”, and user10 is “00000”. In case of 9 channel DVR user, press “0” for figure 0, in case of 16 channel, press button “10”

Password change



Select user → Input password and press change → Press Yes  
 Password input box is displayed. Password can be input with front figure button or text input window.  
 After inputting 5 digit figures, click “Change” button.  
 After that, message pop up window will be shown and press “Yes”.

**Authority**

Administrator can set Authorities for each user. User can use only authorized functions.  
 If user 1 has Menu use authority, when pushing Menu button, authority check window will pop up and user should input the password and if it is correct, user 1 can use Menu function. If password is wrong, message box “Wrong password” will be displayed.



[Authority check]

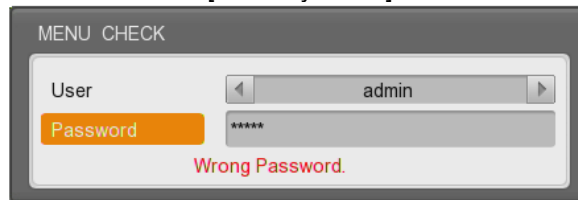

[Password error]

**6.2.4 Utility**

Configure the name of DVR, remote controller ID, Language



**DVR Alias**

Set the name of DVR.

**DVR Keyboard ID**

This menu is to set the address of keyboard when using all functions of DVR by keyboard. Factory

default is "1". If user wants to control various DVR by one keyboard, its address should be set with the different value.

### Remote Controller ID

Max 16 remote controller ID can be set and one remote controller can manage 16 DVRs.  
Registration order for Remote controller.

- Make remote controller direction to DVR.
- Press ID button and figure in accordance with configured remote controller ID.
- If IDs are matched correctly, DVR buzzes.
- Use Remote controller.

### Language

Select Language to use.

### Firmware Update

Can update firmware by USB Memory.

- Insert USB memory to USB port.
- Press Firmware Update button.
- Select [YES] on the pop up window.



- System will reboot.
- Firmware update is done.

### System Log

System Log shows boot status of system and user and configuration etc.

### Factory Reset

Change all configuration value by factory default.



**Config Import/Export**

Export – Save Configuration data in DVR to USB

Import – Apply exported Configuration data to relevant DVR or another DVR.



**System Information**

Display recording status and system configuration of DVR

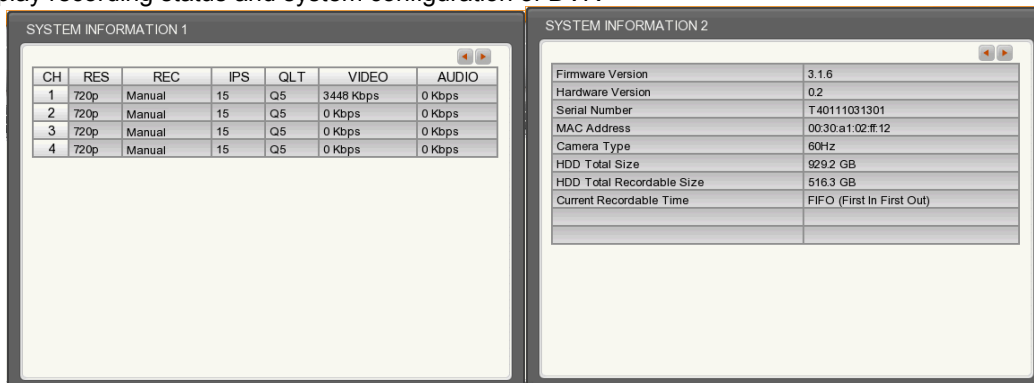

**Caution :** This function is allowed only for system administrator.

**6.3 Network**

This is menu for configuring network



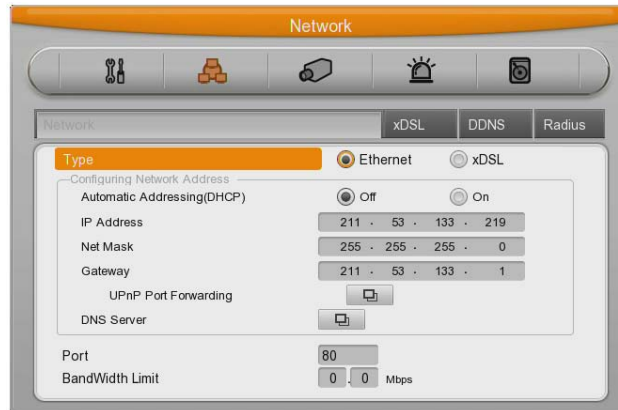

### Type

Configure type of Network (Ethernet/xDSL). If connected to cable modem or Lan directly to DVR, configure by "Ethernet".

If DVR connects to xDSL- one of PPPoE type, configure xDSL. But if it is not type of PPPoE, configure 'Ethernet'.

### DHCP

With DHCP (Dynamic Host Configuration Protocol), all hosts connected to Lan can get Public IP address temporary.

If LAN has DHCP server and it is active, DHCP server allocate IP address to DVR.

Mostly middle and large network use DHCP server in LAN, but in case of small network, NAT(Network Address Translation) of HUB is general.

### IP Addr

**IP Address is for the connection between DVR and Control Center and also for web connection from Webviewer. (But, Net Mask, Gateway should be configured.)**

### Net Mask

**Net Mask makes range of IP address available. It should be received from network administrator.**

### Gateway

Gateway is necessary to communicate IP, it should be received from network administrator.

### DNS Server

DNS1 is mandatory item to regist and use WRS and it should be asked to network administrator.

### UPnP Port Forwarding

It configures port of DVR automatically when DVR is used with internet hub.

### Port

**Port is necessary for Control Center and Webviewer connection.**

**Reference : Basic port is 80 and if using PPPoE modem and AP, be careful typing port number.**

### Bandwidth

**Menu for configuring network data transmission capacity. Without any additional configuration, it works but if user want to set, please let administrator do..**

### 6.2.3 xDSL

DVR is connected to xDSL line and use PPPoE type, please change type by xDSL and configure user ID and Password. User ID and Password should be same as xDSL

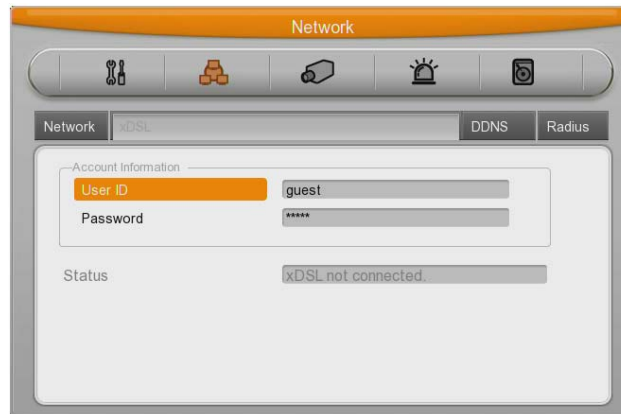

#### User ID/Password

Configure user ID and Password.

#### Status

It shows connection status of DVR.

### 6.3.2 WRS

If DVR is connected to Cable modem or xDSL modem, IP address is changed at every connection to ISP. In this case, changed IP address cannot be known. If DVR using static IP register into WRS server, changed IP address can be known easily when it connects to DVR.



#### WRS Interval

For continuous registry, register intervals should be set to 'WRS Interval'. According to set value of static IP address, it renews the information in WRS server regularly. If user registers the interval '0' or DVR does not transmit any data for 2 days, the data is removed from WRS.

#### WRS URL

This menu is to set server address to register. WRS addresses that Hunt operates now are [www.webgateinc.com](http://www.webgateinc.com) or [mycam.to](http://mycam.to).

### 6.3.3 Radius

It makes to manage account information from several different DVRs to one account using Radius server. Please ask to Administrator before you use it.



To set Radius, Status, IP Address, Port should be set. Set 'Enable' the status to use Radius and enter 'Radius Server IP' to IP Address. Standard port to use is 1812 and specific port number which is from Server is also useable.

'User ID', 'Password' and 'Radius Shared Key' are needed from administrator of Radius server after forwarding DVR account information to him. Use 'ID/Password/Shared key' to register unit to Control Center.

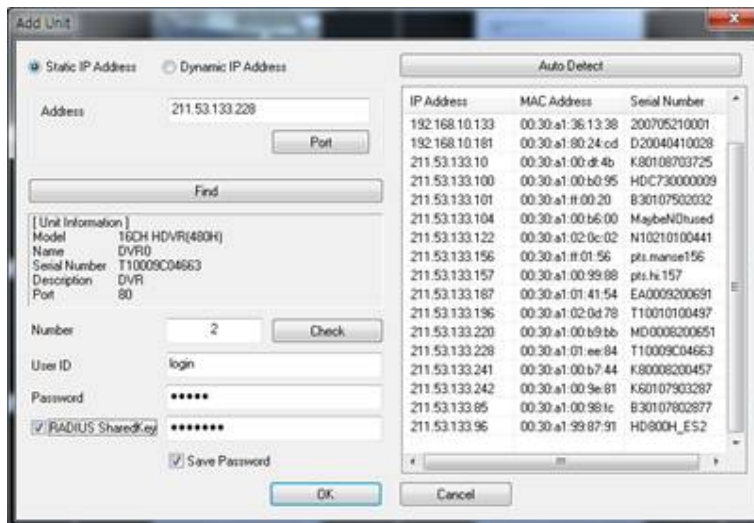

Click the Radius Shared Key and enter ID, Password, Shared Key. Registration is completed of all information is correct.

## 6.4 Device Setup

This menu is for configuring each camera connected to DVR. There are [name] [Status] [Color/black or white] [Brightness] [Contrast] [PTZ] etc.

Configured value will be applied to monitoring and search at the same.



### 6.4.1 Camera Setup

Select the camera to configure in Channel menu.

#### 6.4.1.1 Using Channel

Configure wither using camera or not.

After pressing [Enter], select it using left/right key or mouse wheel.

If user wants to enhance the recording or network monitoring speed, please, set the channel disable.

.

#### 6.4.1.2 Title

Configure camera name.

If pressing [Enter] button or click mouse, test menu will be shown.

For text string, text input box will be shown.



- Use directional key for text input.
- With mouse, just click the text.
- Select the text using up/down and left/right button.
- After selecting the text, press [Enter].
- To delete the text, press [←] button.
- To make a space between letters, press [→].

#### 6.4.1.3 Input Resolution

This shows resolution of camera connected with DVR and user can't change this.

For change, user needs to input 1080p camera.

#### 6.4.1.4 Encoding Resolution

The basic setup value is on 720p. User can change 720p into 1080p only when 1080p camera is connected.

### 6.4.2 Monitor Setup

Main monitor provides all function which DVR supports and with spot monitor can use single channel conversion.



Standard monitor is available to use all functions from DVR.

### Alarm Popup

If specific channel uses MD, Sensor Input, it makes the relevant channel popups as single or multi screen. To use this function, event should be set to 'Always' or 'Custom' and MD / Sensor configuration should be done also.

### The way to composing

The way to compose screen is selecting the target and after selecting right window and press [Enter] button or use mouse. If channel selection is down, press [ESC] button or click mouse light button.

### Covert channel

With Covert menu, user can covert the channel in Live/Playback mode  
In Covert menu, all channel lists will be shown and press [Enter] button and click mouse to tick the channel. Checked channel will not show the video in Live/Playback.

### Display information

Display information is to configure which information will be shown on live view and playback view. In live view, time, channel name, event, recording status, HDD, remote controller ID, text can be set and in playback view, time, command, channel name, event, text can be configured

### User sequence configuration

User sequence can be edited. There are 16 user sequence mode and its interval is from 1 to 60seconds.

## 6.4.3 Audio Setup

With this menu, user can configure Voice Channel, Audio recording, Volume, Synchronization, Mixing.



### Voice Channel

Select audio to use

**Recording**

Configure yes or no of using audio recording. If no, audio will be out only in live view and if yes, Audio will be out in both view modes

**Synchronize Video Channel**

Configure which channel is matched with the input audio. If Audio no.1 is set to video channel no.4, Audio no.1 is output with video channel no.4. Default set is Audio no.1 to video channel no.1.

**Volume**

Configure volume by +, - direction

**Voice mixing**



Select audio in live view. If setting by “Mix On”, all input audio will be out in every channels and if configured certain channel, input audio will be out on the selected channel only

**6.4.4 Text Setup**

Configure Text in Device menu.



**Recording**

**Set On/Off of recording against Text input**

**Sync Text with**

Select channel to synchronize with text.

**Device**

Select the device to input text. Manual, Star Finger 007, VSI Pro are available to select. Star Finger 007 and VSI Pro can be used with defined protocol, and other devices with Manual mode.

**Header check**

It has the various type of data input from the external device (Access Control, POS, ATM etc) but it's not necessary for a device which is supported its protocol by DVR .Like VSI Pro, VSI Pro Hydra, and Star Finger 007, it is not needed when the protocol of these device have implemented on the device. If not, this is the parameter to analyze how the one of data is constructed from the text data that is input continuously.

Namely, all data has the first and the end. Header indicates the information that already inserts to inform its starting. Therefore, Header information is defined here to acknowledge its starting of a data. The reason of 2 Header is to detect maximum 2 data out because each device can output various dates.

**Delimiter**

Delimiter value can be different according to the manufacturer, please, refer to the product manual or seller.

**Time out**

Following lines defined here means maximum number of text line from one data. Even if there is standard data, there can be a short and long data. For example, there are 3 lines to write names on ATM. But some may need only First name & Last name to register. Which it means requires only 1 shorter than other ATM users. It is to decide the last line of the one data register as final complete data to save after an hour's consideration of register later because DVR cannot recognize it automatically.

**Lines**

Define how many lines will be shown.

**Caution : external device cannot be recognized, please, ask to the seller.**

**6.4.5 Serial Setup**

DVR has 3 serial ports. One is RS-232C(D-Sub) and the other 2 ports are RS-485(Terminal).



**Serial Port**

Select Serial port.

**Device**

Select the connected device.

**Interface**

Configure which interface user uses. COM1 is for RS-232C, COM2 and COM3 is for RS-485

**Baud rate/Parity/Stop Bit/Data Bit**

In put suitable value according to external device.

### 6.4.5.1 PTZ Setup

Additional configuration for PTZ Address, Port PTZ.



#### PTZ Home

Shift to preset assigned if it has no movement in certain time while PTZ control.

#### PTZ Idle Time

If it has no movement during configured time, shift to PTZ Home.

#### PTZ Port

Select Port for PTZ

#### PTZ Address

Configure the address configured in PTZ.

## 6.5 Event Setup

There are 5 items such as event, Text, Sync Event, Preset, System event



### 6.5.1 Event Check

There are 3 items – Always, not apply, Timezone.

In case of Timezone, with similar configuration window like schedule, user can configure event per weekday/time.





- INDEX : Schedule configuration from 1 to 50
- Weekday
- Time
- Delete : delete INDEX

**How to configure**

If configuring INDEX,weekday,time, they are displayed on the table.

If clicking and selecting start time and end time of recording on the table, Index,weekday,time will be shown on the table.

**How to delete**

Select INDEX and click Delete button.

If clicking Delete button without selecting INDEX, previously selected INDEX will be deleted and from the latest INDEX, it will be deleted in order.

**How to change**

- ✓ After selecting INDEX, change directly weekday,time.

**6.5.2 Sync Event**

Configuration for Event synchronization

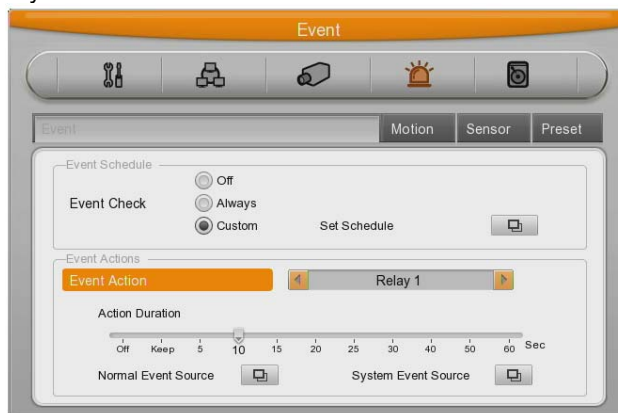

**Event Action**

There are 7 actions – relay 1 to 4, buzz, E-Mail, FTP

**Action Duration**

Action Duration runs if relay and buzz are configured, and goes on during the configured time. E-mail works by configured time interval.

**Normal Event Source**

User can configure Sensor, motion detection, V-loss, Text.

Model	Sensor	MD	V-Loss	Text
HVRM-HD400H	4ea	4ea	4ea	1ea
HVRM-HD800M	8ea	8ea	8ea	1ea
HVRM-HD800M	16ea	8ea	8ea	1ea

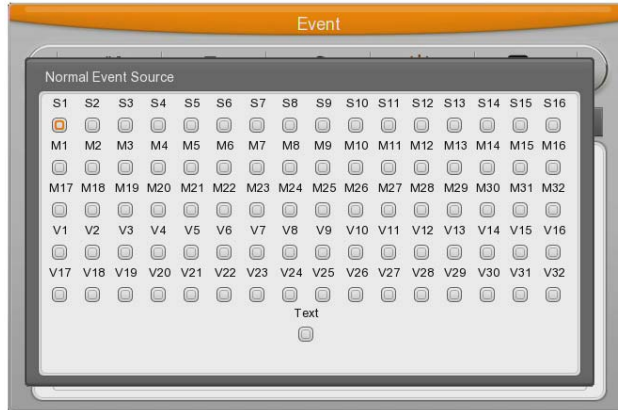

**System Event source**

System Event source can configure Bad block, Disk full, Fan error, authorization failure, WRS registration failure, Mirroring failure, Abnormal recording stop.



**E-mail address**

Input E-mail address to get event alarm by E-Mail.

**E-mail address**

Please fill E-mail address with receiver's E-mail address.

Input mail format should be xxxx@xxxxxx.xxx and user needs to use only English and number to compose E-mail address.

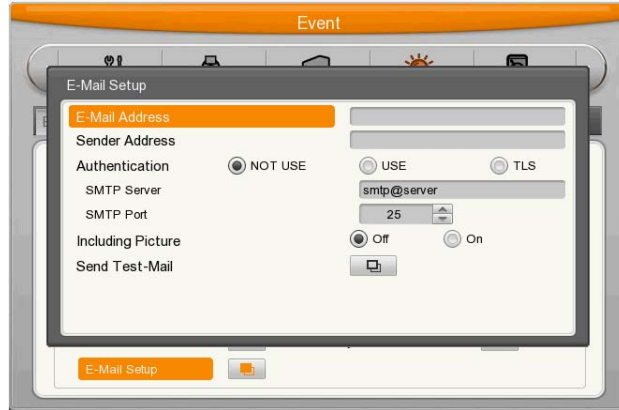

**Sender Address**

Sender's E-mail address is set when user use E-mail for output selection and user setup E-mail address as xxxx@xxxxxx.xxx. User doesn't need to input fixed address for E-mail but address which can be distributable.

**Authentication**

There are 3 ways to send E-mail, Non-authentication sending, SMTP server authentication, TLS authentication. Non-authentication is to send e-mail without authentication from authentication server. SMTP server authentication is to send e-mail after an authentication of sender's e-mail address from SMTP server. TLS authentication is to send e-mail after an authentication of sender's e-mail address from TLS server

**Including Picture**

In general event, when sensor, MD, V-loss events are generated, the event information and Channel video will be sent to e-mail together.  
But system event just send system event information.

**FTP sending**

It send 1 video image of event to FTP server when event is occurring.



**FTP Uploading**

It makes FTP function On or Off.  
To use FTP sending function, select 'Normal Event' or 'System Event'.



**Server URL**

Enter the FTP server address to send image.

**User ID**

Enter the relevant ID when FTP server authentication is set.

**Password**

Enter the password

**FTP Directory**

Select Folder to save image

If folder is not indicated, the image is sent to the folder which server selects.

**Twitter connection**

Twitter can be connected to send single image or text message about event information of the channel when event is triggered on the channel

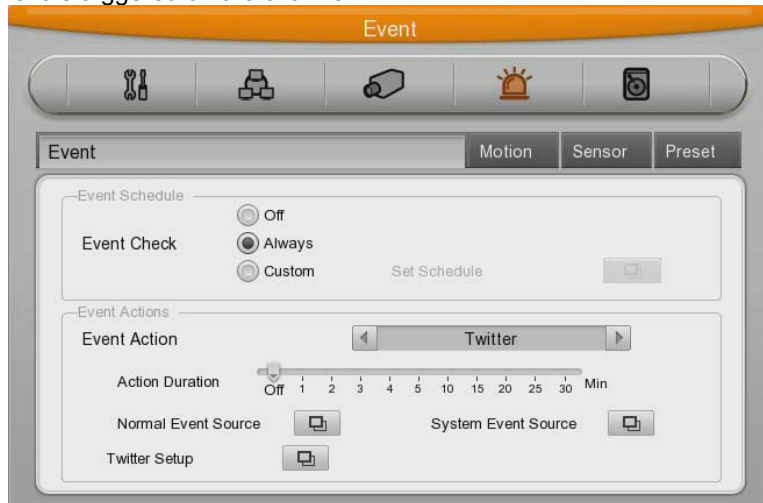

**Action Duration**

This is setup for transmission duration of the Twitter

Please select Normal Event or System Event to be used for Twitter transmission

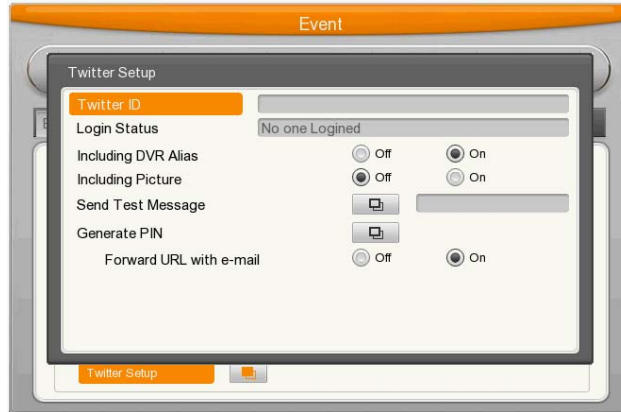

**Twitter ID**

Type in Twitter account to be used

**Logging Status**

It shows current log in status

**Include DVR Alias**

This is setup if DVR sends DVR name together with event status information to twitter address.

**Including Picture**

This is setup if DVR sends recorded image in image file together when DVR transfer event status information to twitter address.

**Send Test Message**

This will test if Twitter configuration setting is well achieved.

**Generate PIN**

If click on this, it will let user know URL for login.

**Forward URL with e-mail**

This is setup if DVR send event status via E-mail as well when DVR send event status to Twitter

**6.5.3 Motion Detection**

The Motion detection can be used to notify user of detected motion on each channel or all channel.

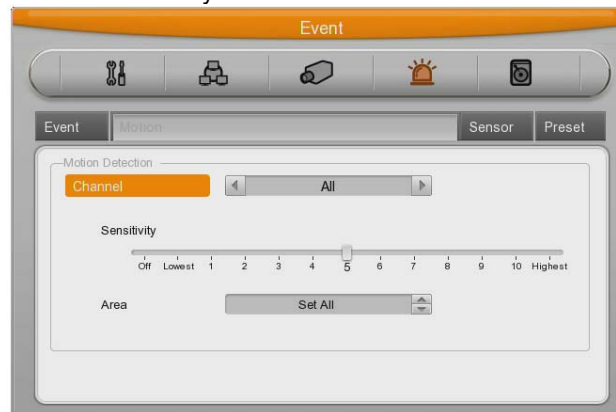

**Channel**

All or certain channel.

**Sensitivity**

Sensitivity can be configured from min.1 to max 10.

**Area**

Select detection area.

User can select all or certain channel.

**User Area**

When selecting per channel, it can be configured.

1 grid size is **22x15** and factory default value is All. If pushing user area, configuration window for detection area.

With direction key, select area and press [Enter] or click mouse. And press “ESC” button or click right mouse button, shift to the previous menu.

**6.5.4 Sensor**

This menu is to setup the existing sensor input and type of sensor.

16 input Sensor has 2 types, Normal Open(N.O.) and Normal Close(N.C.).

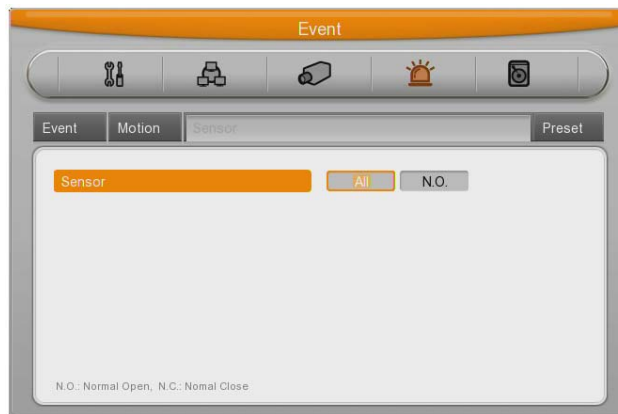

**6.5.5 Preset**

In PTZ function, make configured preset work according to sensor input.

Please, configure preset per PTZ.

After selecting channel in preset menu, select event to work preset.

Event can select sensor, MD, Text, its preset can be configured up to 16

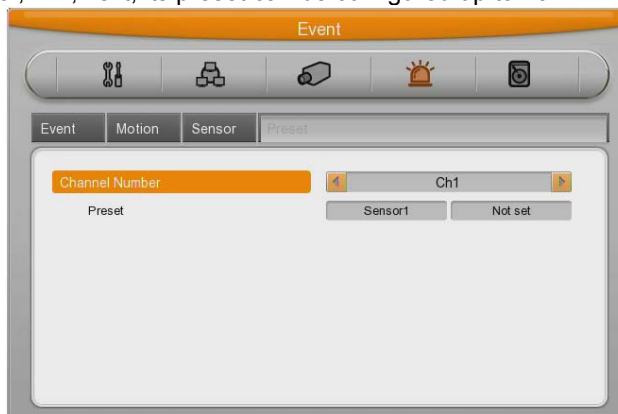

## 6.6 Recording setup

There are 3 mode for recording – schedule recording, manual recording, event recording. Schedule recording records according to the configured schedule. And manual recording records via pushing “REC” button and event recording records when events are on.

### 6.6.1 Program setup

Using [Program], adjust frame rate and quality configure recording program for Manual&Event&Schedule.



In event recording, one channel can record up to its max frame rate and if setting 2 channels as event recording, their recording frame rate will be adjusted automatically.

#### Program

There are 9 programs from A to I composing recording quality and resolution per channel. Please, refer to 3.5 program configuration value.

#### CH (Channel)

Display the channel figure.

#### Input Res

It shows resolution per camera connected to each channel.

#### Rec. Res

It shows resolution for each recording channel.

DVR records in 720p when 720p60 inputted to DVR as well as recording in 720p will be possible when 1080p30 inputted to DVR.

#### F (FPS)

It means frame per second and can select 1 to 30fps per second. Max. Frame can be changed according to the configuration.

#### Q (Quality)

There are 5 recording quality - Q5/Q4/Q3/Q2/Q1. Recommended quality for event recording is Q3.

## 6.6.2 Manual/Schedule recording setup

With the change of recording mode, manual recording or schedule recording can be at one's choice. And their resolution, frame rate, quality will be in accordance with the program.

### 6.6.2.1 Manual Recording

Only in manual & event recording, manual recording runs and when pressing [REC] button, recording starts. If you want schedule recording, recording mode should be Schedule & Event.

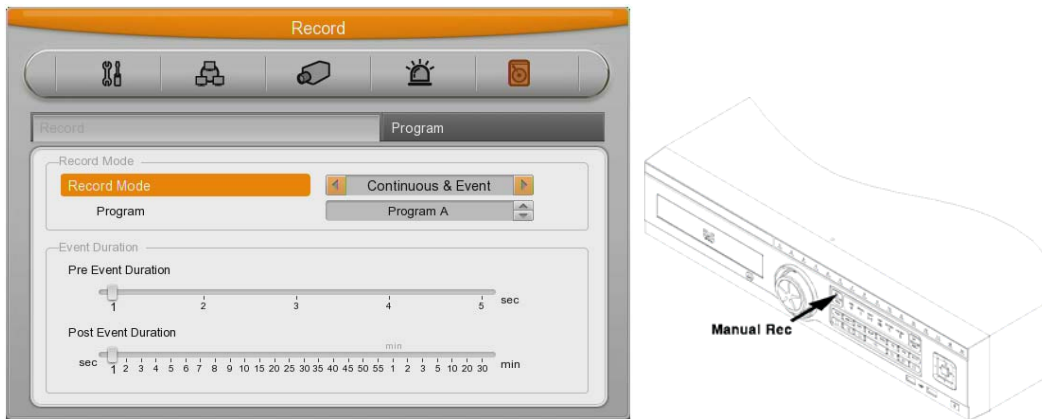

### 6.6.2.2 Schedule Setup

It records according to the programmed schedule automatically. Make recording mode Schedule & Event and configure day and time.



Check and select each program default value and select one of 9 programs from A to I or Several programs. Below picture show program A.





- INDEX : Schedule unit from 1 to 50
- Weekday : Set the day applicable
- Program : Set recording program(A~Z)
- Time : Set time applicable
- Cancel : Cancel per INDEX

**Configuration**

Configure INDEX, weekday, program, time.

If selecting recording start time and end time on the table by mouse, its Index,weekday,program will be displayed.

**Deletion**

Select INDEX and click Delete button.

If clicking delete button without INDEX, previously selected INDEX will be deleted first and after that, from the largest INDEX in order.

**Edition**

- ✓ Select INDEX to edit and change weekday, program,time directly.
- ✓ In case that INDEX 50 are all configured, select the time zone to change by mouse click and click the time again, previous configuration will be deleted and new configuration will be shown.
- ✓
- ✓ Caution : If selecting the same time twice, “!” will be shown on the chart.
- ✓ When configuring time sector, previously configured time can not be included.

**6.6.2.3 Event recording setup**

Select resolution and frame rate and quality for event recording.

There are 4 triggers – Sensor, Motion detection, Text, Digital input.

First, select the program and check resolution and frame rate and quality of the channel.

(refer to 6.6.1, program configuration)

Event recording can sync manual&event, Schedule&Event.

Select among Manual&Event, Schedule&Event in “Recording mode” of [Record configuration]-[recording].

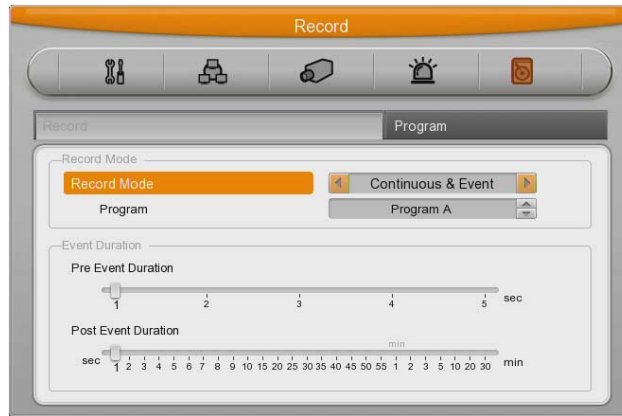

**Reference : Please, check below to configure event recording.**

1. Select one of Manual&Event, Schedule&Event.
2. In program configuration, set frame rate by 0 fps in general mode and only configure Event frame rate.
3. Set Event applying time.

**Event Time configuration**

Configure time for event recording and there are 3 mode – Always, no use, Timezone. In “Always”, event works all the time and in “Timezone”, works during configured time. Configuration of Timezone is similar with schedule configuration and can configure weekday,time for Event.



- INDEX : Set from 1 to 50
- Weekday : Set weekday applicable
- Time : Set time applicable
- Deletion: Delete per INDEX

**Configuration**

Configured INDEX,weekday,time will be shown at once. Select recording start time and end time in order and its INDEX,weekday,time will be shown.

**Deletion**

Select INDEX and click Delete button

If clicking delete button without INDEX, previously selected INDEX will be deleted first and after that, from the largest INDEX in order.

**Edition**

- ✓ Select INDEX to edit, and change the values.
- ✓ In case of being configured by INDEX 50, click and select time to edit and if clicking the time table again, previous configuration will disappear and new configuration will be shown.

**6.7 Configuration Tool**

The most of console settings are done by Control Center Configuration Tool program which is Manager Software.

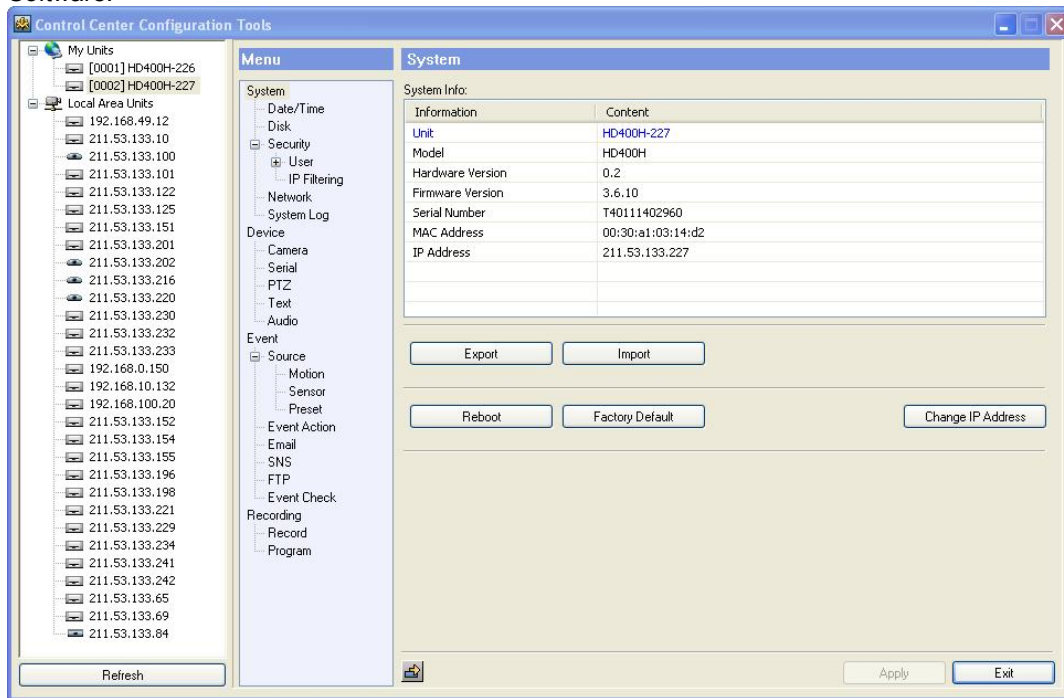

Site Tree      Menu      Configuration Page

The full screen of Configuration Tool is as above and its contents are such as site tree, menu and configuration page.

**6.7.1 Site Tree**

The units which is listed in unit tree are registered in main view of Control Center and it is not possible for user to register/delete/revise them using Configuration Tool.

The list is periodically synchronized with “My Units” of Control Center. And when user press the “Refresh” button in lower part, all the information will be renewed rightly.

The details which user can configure will appear in menu if user clicks specific unit. System setting page will also appear default value in configuration page..

**6.7.2 Configuration Page**

As “Apply” button will be activated when user changes configuration of the page, user will just press this button to apply new configuration.

User should press “Apply” button after changing setting of each configuration page.

If user moves to another configuration page without pressing "Apply" button, dialogue box will appear to ask user whether new configuration will be applied.

### 6.7.3 Menu

#### **Date/Time**

User can set Date, Time, Timezone, NTP of unit

#### **Disk**

User can set Add/Add Used/Remove/Confirm Remove and Auto Deletion, Disk Full Alarm, Block Playback(Recording), Temp. Over on installed disk.

#### **User**

User can set password, authority on the manager and user.

#### **IP Filtering**

User can limit or permit connection on particular IP Address.

#### **Network**

User can make all related setting on the network such as IP Address, DDNS, Port, Radius Server, Network Stream.

#### **System Log**

User can check and save System log.

#### **Camera**

User can set channel name and it's activation.

#### **Serial**

User can set related configuration on outer connection devices such as PTZ, Keyboard, Text.

#### **PTZ**

User can set PTZ configuration on the channel.

#### **Text**

User can set text configuration.

#### **Audio**

User can make audio recording per channel along with Gain setting.

#### **Motion**

User can set motion sensitivity per channel and motion area.

#### **Sensor**

User can make Sensor configuration.

#### **Preset**

User can configure Preset action with event.

#### **Event Action**

User can set Event action on normal event and system event.

#### **E-Mail**

User can configure all settings on E-mail transmission.

#### **SNS**

User can configure all settings on Twitter transmission.

#### **FTP**

User can configure all settings on FTP transmission.

#### **Event Check**

User can configure Event action schedule.

#### **Record**

User can configure Recording schedule.

#### **Program**

User can configure save value per each program.

## 7 Web Viewer

WebViewer is Web application program loaded to monitor real-time image or to monitor the images recorded through Web browser to PC located remotely.

WebViewer is divided into Login page and Monitor to do monitoring real-time images, Playback to replay recorded images.

### 7.1 System requirement

	Minimum	Recommendation
CPU	Core2Duo / 2.0Ghz	Quad Core / 2.6GHz
Main Memory	2GB	4GB
Video Memory	128MB	512MB or higher
Display	1920 x 1080 (with 32bit color) or higher	
HDD	80GB or higher	
OS	Windows XP Professional(SP2이상) / Window Vista Business(SP1 이상)	
Others	DirectX 9.0 or higher	

### 7.2 Login

USER LOGIN

IP Surveillance system

USER ID: admin  Save ID

PASSWORD:

ActiveX  Java

LOGIN  RESET

**Your System Check !!**

ActiveX for internet Explorer 6.0 or the above.

Java Viewer for Safari 4.x and Firefox 3.x or the above

To download the latest Java applet, please visit <http://www.java.com>

After input IP address that set to system, then WebViewer Login page will be connected.

Input the set of User ID & Password, click 'LOGIN' to access.

If didn't change the password in Control Center, ID and Password will be admin/12345.  
ID cannot be changed.

### 7.3 User Setup

To access WebViewer, user authority and password can be changed in DVR or Control Center configuration

In account menu, user password can be changed.

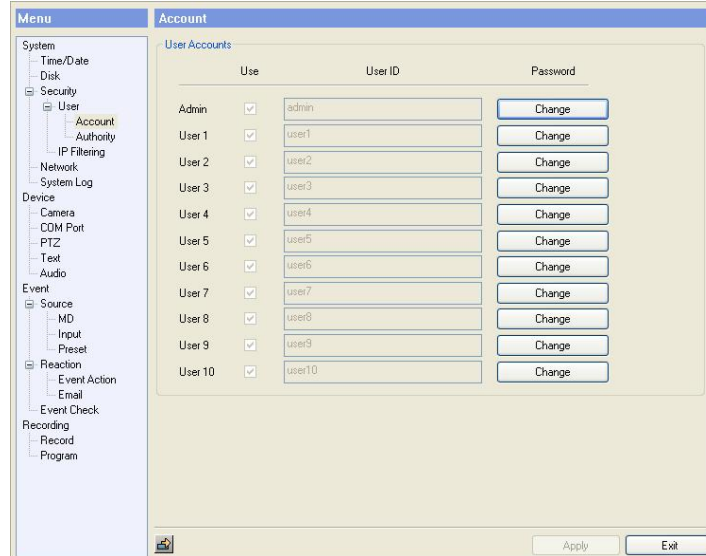

Basic admin password is “12345” and user password is like “11111{“, “22222” ~~, user10 is “00000”. Valid password is 5 digit.

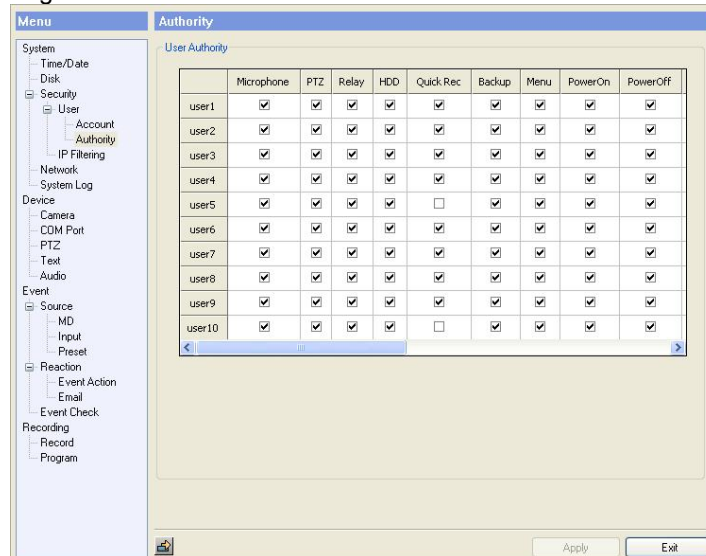

Authority configuration is almost all the same in DVR and Control Center. But quick recording, backup, audio, yes or no of using channel are only possible in Control Center.

### 7.4 Browser available

WebViewer is optimized to Windows Internet Explorer 6.0 or higher in PC for smooth use.

#### Webviewer Installer

Login page provides manual installation program to use WebViewer function.

PC that access to WebViewer first installs ActiveX to use WebViewer's function. At this time when installation is not smooth, installation program needs to download from Login Page and install manually.

**Caution**

When install WebViewer Installer, it must close all program related to Control Center. It might not be efficient to install.

## 7.5 Monitor

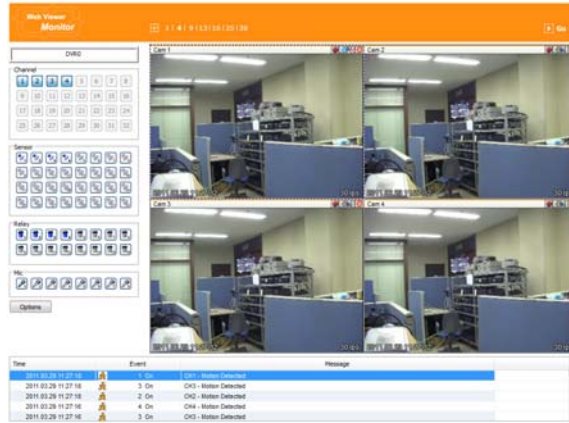

When it is authorized with User ID & Password input at Login page, it moves to monitor page. At Monitor page, monitor real time image of cameras connected to DVR, or it can control PTZ camera, Relay, and use Microphone function according to user's authorization.

Study introduction of each Monitor part and functions of the page.

### 7.5.1 Screen division and changing video position

When access to first monitor page, it is displayed into 9 divisions, 16 divisions or 32 divisions according to number of channel.



It can to change to 1, 4, 9, 13, 16, 25, 36 divisions by click number on top of page. Also, it can change to 1 channel mode by click any one of channel image

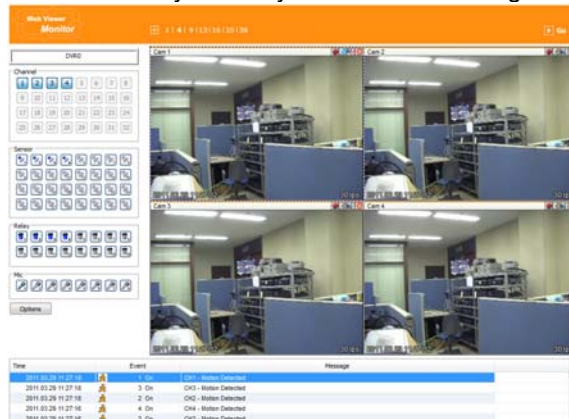

Double click on one of the playback screen to convert in 1 channel mode

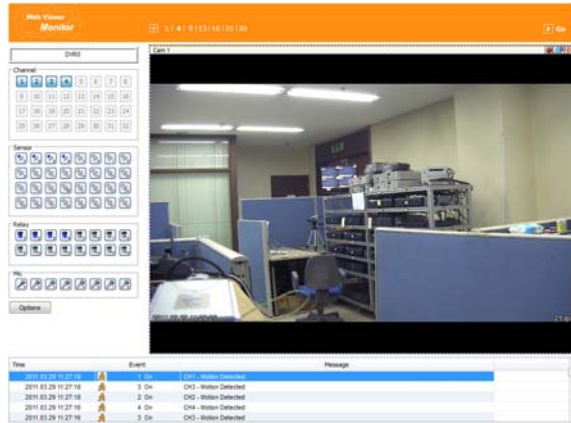

After conversion to 1channel mode, double click on screen to return to previous division channels.

At division screen, it can change screen location.

If 3channel image moves to 1ch, drag 3ch image and drop on 1ch location so as to exchange between 3ch and 1ch image

### 7.5.2 Move to Playback



Move to playback with clicking the above image.

### 7.5.3 Channel On/Off



It is On/Off button for the Channel located to left in page. Click the channel wanted to On or Off. And Default is On.

### 7.5.4 Sensor Indication

The icon indicates when sensor occurs in system.



When it sensors, relevant sensor icon comes to Red, and indicates sensor number of video.

### 7.5.5 Relay operation

It can On or Off Relay of the unit. Click the number button to activate Relay On, then the icon



Changes from Blue to Orange color

Relay is need user's authority. Refer to user manual in the unit for the setup of User's authority of Relay.



## 7.5.6 Using Microphone



It can On or Off the use microphone. Default is Off and it is changed from the Blue to Red when click the button for the use Mic.

## 7.5.7 Event Data

Time	Event	Message
2011.03.29 11:27:18	1 On	CH1 - Motion Detected
2011.03.29 11:27:18	3 On	CH3 - Motion Detected
2011.03.29 11:27:18	2 On	CH2 - Motion Detected
2011.03.29 11:27:16	4 On	CH4 - Motion Detected
2011.03.29 11:27:16	3 On	CH3 - Motion Detected

It shows real time event data occurred at the bottom of monitoring page.

Indicated Event data list are as follow.

### (Table, Event Icon)

Icon	Function
	Motion Detect On
	Sensor Input
	Relay Output On
	No Video, Video Detected

## 7.5.8 Video Recording & Save

### 7.5.8.1 Video Recording

During monitoring, it can record max. 10 minutes of video by click Quick Recording button . During Quick Recording, recording time is indicated on video



During video recording, if click Quick Recording button to stop recording and open the dialogue box to store recorded files. At this time, user can save it to the directory with any file name by user.

Saved recording file is saved into "\*.re4" file format. re4 file can playback through Control Center Playback program or Mini Player program.

### 7.5.8.2 Saving Vido

There are 3 types for saving Video - jpg, bmp, eye, saving means the function to record 1 frame of current monitoring channel.

To save video, select the channel and click right button of mouse. and select "Save As" and point out the location and press Save button.

## 7.5.9 Using PTZ

Among the icon on top of video on monitoring, click 'PTZ' to activate interfacing to control Pan, Tilt, Zoom, and Focus. But, when PTZ camera is connected and ready to set PTZ, the button is activated to use the functions.



### Pan, Tilt Control

Mouse is on the image and click right button to pop-up menu for the selection or "PTZ" or  button. Then it show Cross line on the middle of screen and click image to operate Pan, Tilt. At the middle click Left/Right direction to control Pan, and Click Up/Down direction to control Tilt. Click as far from the middle to activate Pan/Tilt faster.

### Zoom, Focus Control

Move mouse to the edge of left & right to see slide bar for Zoom, Focus. The unit Area Zoom In available has Zoom Zero operating button. It can zoom in/out using slide bar at left of image, left slide bar can control Focus.

### Move to Preset

In case of Preset set, Mouse on image press right button for pop-up menu and "Goto Preset" is indicated additionally. When select Preset list, it moves to Preset position selected. Preset should be set up by user in advance.

### Activating Auxiliary

In case of Preset set, "Auxiliary" is indicated additionally, and it operates action when select registered menu.

### Reference

Supported PTZ camera list can be referred to '4.8 PTZ manipulation.

### 7.5.10 Using Audio



In case of Channel setup sync with Audio, press right mouse button on the image to activate pop-up menu to "Listen" or activate Audio listen button. First default is Mute. In case of listening Audio, select pop-up menu or button. After cancelling mute, control audio volume. It can mix several channels of audio

### 7.5.11 Closing Video Channel

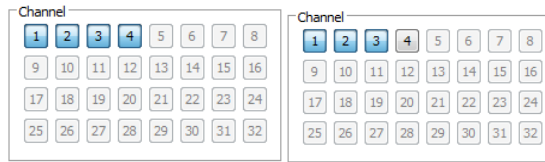

Cancel for disconnection of image monitoring by click 'Close' at top right on screen, then it comes to black screen.

To reconnect the channel disconnected, it can reconnect relevant channel using 'Channel On/Off' menu.

### 7.6 Playback

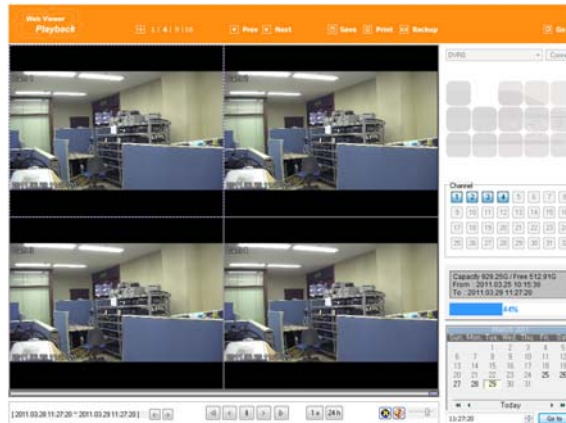

This page is to playback recorded images, and user who has authority of 'HDD' among user ID or administrator can use this function.

Playback that is made up 16 divisions can play the images by searching through colander by recording period and moving the period. It can backup recorded image and also print Pause image or save to Bmp file.

### Video Division & Changing Channel



Playback supports 1, 4, and 4 divisional screens. It can select division using menu on tip of page as above picture. 32ch DVR can call the channel using Group moving button as follow



### Image recording



It can save playback image to BMP file.

Click mouse to channel to save. Dotted line will be surrounding to the selected channel, and click 'Save' button.

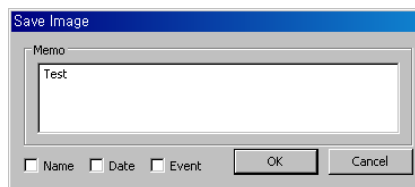

Save large dialog box appears, then it can input message or select channel name, date, event data. Press 'OK' to open dialog box for the saving location, then save bmp file.

## Print

Select image with mouse for the channel to print image saved, and then click 'Print' button.

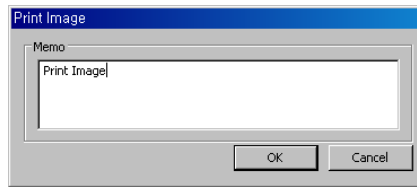

Window comes to input Memo, and click 'OK' button to print the image through the printer connected. Print material includes 'Printing Date', 'Channel name', 'Recording Date' 'Event', 'Memo'.

## Backup

There are re4 (Multi channel) and avi(single channel) Set From, To time and select the channel for backup

Point out the location for backup. Input in Password/Verify.

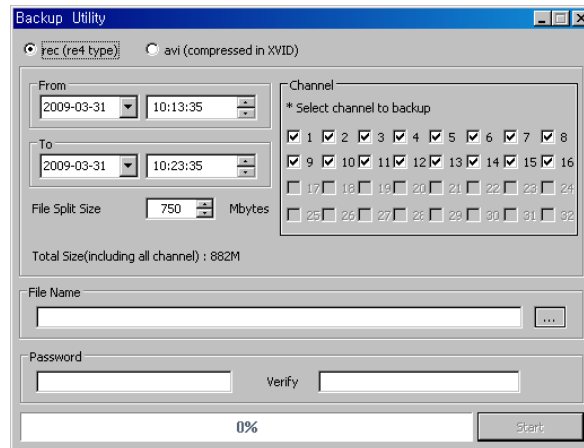

## Web Monitor



Click 'Go' button at top of page, and it can move Web monitor page.

## Channel On/Off

It is the same function like Channel On/Off function at Web Monitor.

It is Channel On/Off button located on right of Page, and click On or Off page for wanted channel. Default is On.

Disabled Channel button refers to do not support and relate to this unit.

## Saving time & Checking Rec, Capacity

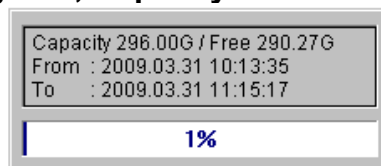

It indicates total capacity of HDD & remains and shows Starting date & Last date of recording. Also it

shows percentage (%) for HDD capacity.

### Searching Calander

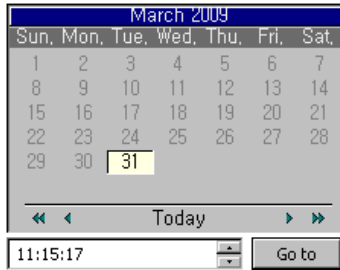

Recorded date is abled in black color, and others unrecorded date disabled in grey. Select button after select date & time so as to playback images on the date & time selected.

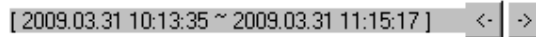

'When click 'Go To' button, it indicates for 24hours from the time selected at left bottom. As above picture, it is possible to change the time zone with '24h' button.

### Functional function at the button of monitor



- Indicates playback range of recorded image.
- Press button as the time set at (5) so as to change the time zone to playback in forwarding and backwarding.
- From left button, it can 'Move a frame back', 'Play backward', 'Stop', 'Play', 'Move a frame forward'.
- It is the function to set play speed. After click the button, it can set the play speed '0.5x, 1x, 2x, 4x, 16x, 32x, 64x, and All'.
- It is the function to set play area. After click the button, it can select play area '10min, 30min, 1hour, 3hour, 6hour, 12hour, 24hour'.
- It can select DirectX use or not. If check DirectX mode, it can play image into Direct Draw based on graphic card and performance of PC.
- It is the function to set audio play or not, and volume.

## 8. User manual for Mobile Viewer

Java viewer is a web viewer to use in Java.  
 Java should be installed in login screen to use Java viewer.

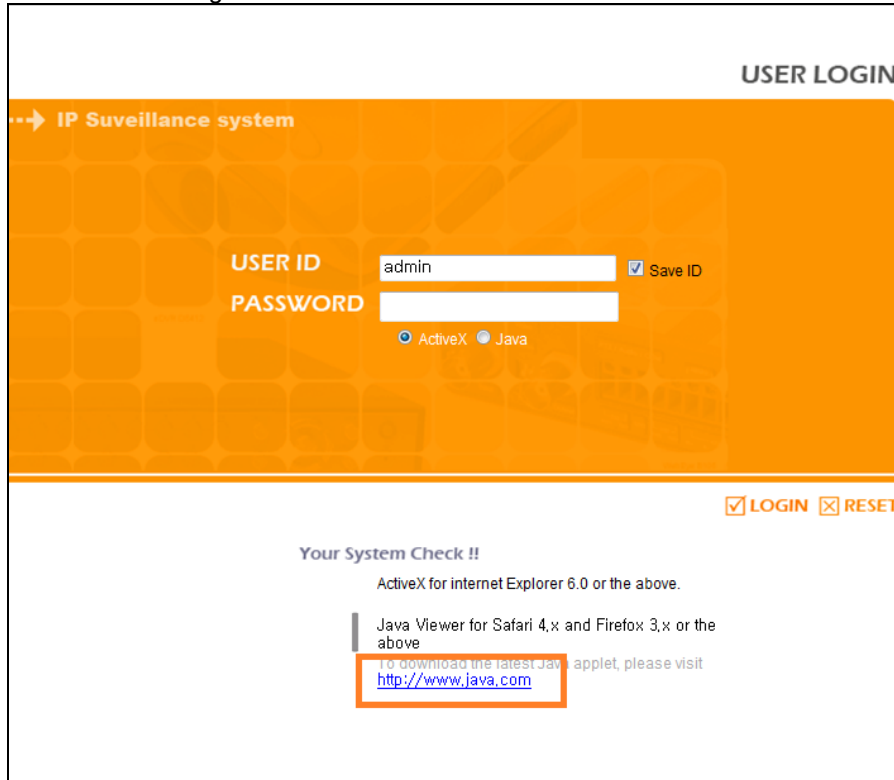

After an installation of Java manually, select “Java” in below of Password window and login.  
 Then single screen of video channel 1 is displayed

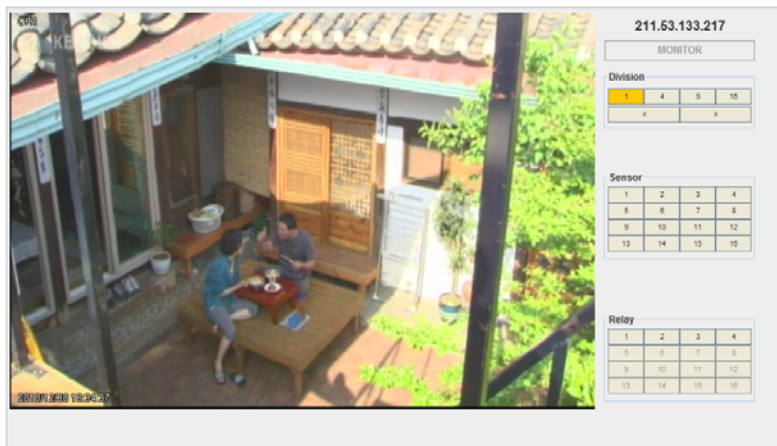

Multi screen display, Event, Relay can be used in Java viewer.  
 To change Multi screen display, click 1,4,8,16 in right side

Mobile viewer is viewer service to monitor video via mobile device.  
 To access mobile viewer, user uses mobile device supporting Wi-Fi or smart phone or 3G.

### Log-In page

Below picture is Mobile viewer log-in page.

To access log-in page via mobile viewer, please, type the address like <http://IP/mvmenu.html>.

Below image is accessed login page to <http://211.53.133.187/mvmenu.html> .

To do log-in, please, enter ID/PW and select Resolution and channel number and cycle and push [0] Start View button.

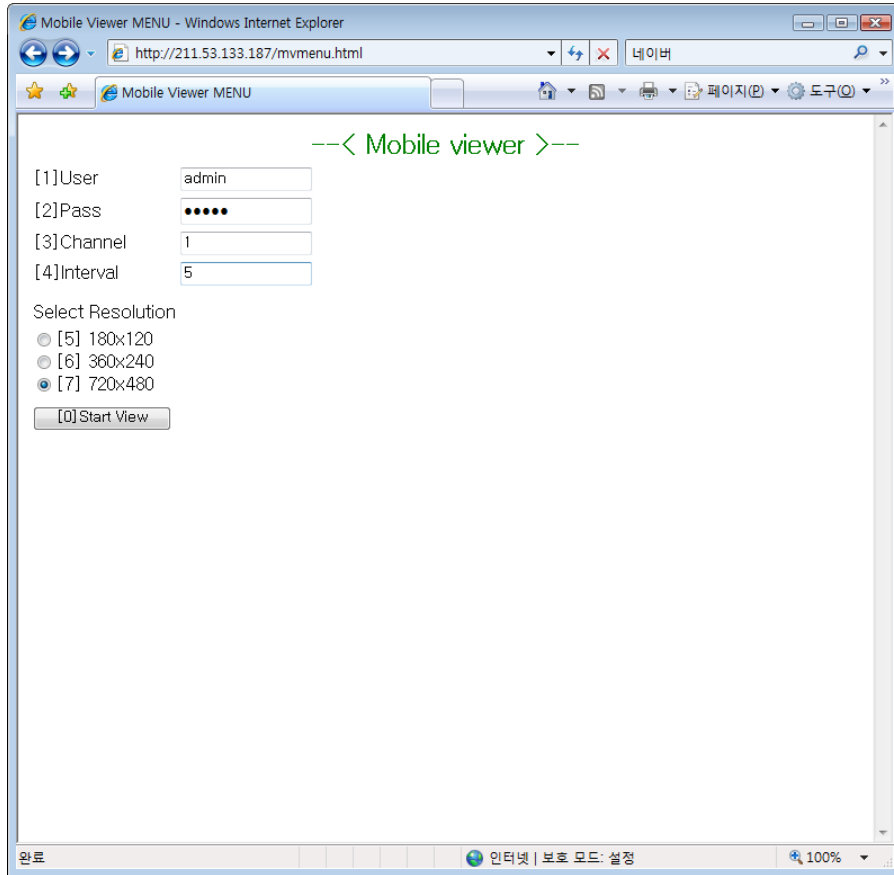

### Monitoring page

This is the page on Log In.

It shows selected channel video and functions right below the screen.

**For functions, please, refer to the below.**



- [0] MENU : Move to Log In page
- [1] CH- : Move to the previous channel.
- [2] UP : Move to upside of Pan Tilt movement
- [3] WIDE : Zoom Out action
- [4] ← : Move to left side of Pan Tile movement
- [6] → : Move to right side of Pan Tile movement
- [7] CH+ : Move to the next channel
- [8] DN : Move to downside of Pan Tilt movement
- [9] TELE : Zoom In action



## Trouble shooting

### 1. DVR booting failure

1. Check the power
2. Check Power cord

### 2. No video on monitor

3. Check monitor power
4. Check cable between DVR and monitor
5. Check monitor cable port
6. Check DVR power is off
7. If monitor video is gray mode, check the camera type(NTSC/PAL) and reboot.

### 3. No video in some of channel

8. Check Camera power
9. Check Camera video input
10. Check DVR input port
11. Check On/Off of Activity configuration of Screen
12. Check Covert configuration of Monitor

### 4. No recording

13. Check Disk Manager if HDD is mounted or not
14. Check recording configuration

### 5. No playback

15. Check recording configuration
16. Check button

### 6. If video is too much bright or dark

17. Check Camera configuration
18. Check and dismantling power cable near video cable.
19. Check Brightness, Contrast of screen

### 7. Remote controller is not working

20. Check Remote controller battery
21. Check Remote controller ID
22. Check Remote Controller manipulation

### 8. If front button is not working

23. Check DVR Power
24. Check Screen Lock

### 9. If network is not working

25. Check if Network cable is connected
26. Check DVR IP
27. Check Computer IP
28. Ping Test
29. Check PC specification if Webviewer video is not shown.

### 10. The cases necessary to contact the shop

30. In case of extraordinary working(ex: noise, smell or fume)
31. Connector breakage of power cable
32. In case that rain or water is in the product
33. In case that liquid or foreign is in the product
34. If the product is not working in accordance with the manual.
35. In case of breakage from product dropping
36. In case that product performance drop dramatically

## Check the manufacturing date

It can be checked with its S/N(Serial Number)..

### S/N : Serial Number

It means composite 12 digit number with product model name and production year, month, and week. It can be found on the attached label attached on the bottom of product or system info of configuration tool or system information 1 of DVR Func menu.

### Serial Number Structure

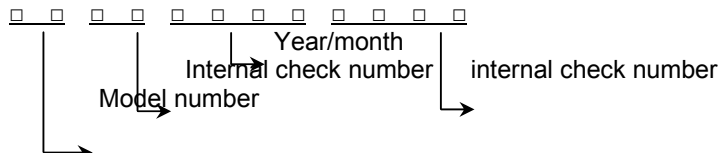

- (1) 1~2 digits : Identify Model name of product
- (2) 3~8, 8~12 digits : Hunt internal number
- (3) 5~6 digits : Manufacturing year
- (4) 7 digits: Manufacturing month

Please see the below table for manufacturing month.

Jan	Feb	Mar	Apr	May	Jun	Jul	Aug	Sep	Oct	Nov	Dec
1	2	3	4	5	6	7	8	9	A	B	C

### The example of verifying manufacturing date using serial number

The below S/N can be verified as following as:

『 **T40111031303** 』

- (1) "T4" means "HVRM-HD400H".
- (2) "01" means internal management number.
- (2) "1103" means it was produced on "March of 2011 year".
- (3) "1303" means serial number.

## Available HDD

Please ask to seller about HDD available with DVR.

## Compatible CD/DVD list

DVD-R manufacturer	CD-R Manufacturer
Mitsubishi(×16 recommended)	Mitsubishi(×52 recommended)
TDK(×16 recommended)	TDK(×52 recommended)
Imation(×16 recommended)	Imation(×52 recommended)
Sony(×16 recommended)	Sony(×48 recommended)

# Product Specification

## HVRM-HD400H

<b>Video input</b>	
Video input standard	HD-SDI SMPTE 292M
Connectors	4 ch HD-SDI inputs BNC connector
<b>Main Video output</b>	
Vout	HDMI / VGA 1,4 mode User defined sequence / alarm pop-up 1920x1080p at HDMI / VGA port
<b>Recording</b>	
Compression	H.264 / JPEG
Resolution	1920*1080, 1280*720
Rate	60 fps at 1080p 120 fps at 720p
Quality	5 levels
Mode	Manual & Event / Schedule & Event
Schedule	24hrs / 7day
<b>Playback</b>	
Mode	Instant playback / Search
Speed	60 fps at 1080p 120 fps at 720p
Search Type	Time, Calendar, Event, Thumbnail
Block Playback	24 hours ~ 31days
<b>Event &amp; Alarm</b>	
Event source	MD, Sensor, Text
Event check schedule	24hrs / 7day
Event Action	Recording, Relay, E-mail, Buzzer, Pop-up, Warning Message, PTZ preset
MD Area	22x15
Sensor input	dry contact (N.O. or N.C. selectable)
Text input	POS/ATM support, AVE VSI Pro/Hydra support
<b>System Alarm</b>	
Alarm source	HDD fail, HDD almost full, Fan fail, Pwd fail, WRS fail
Alarm action	Warning message, buzzer, e-mail, relay
<b>Audio</b>	
Input/output	4 RCA input, 1R CA output
Compression	16KHz, 16bit sampling ADPCM
Direction	Both
<b>PTZ</b>	
Protocols	32 models including Bosch, Pelco, Sony, Merit-lilin, Honeywell
<b>Network</b>	
Interface	1 10/100 Ethernet
Type	Fixed IP, Floating IP, xDSL
WRS	supported
Bandwidth Limit	supported
NTP	Server/Client/Both
Users	10 monitoring, 2 playback
Streaming	1 H.264 same as recording 1 additional H.264 smaller than recording 1 JPEG for e-mail sending or mobile
<b>Security</b>	

User Level	1 admin, 10 users
User privilege	Menu, PTZ, Relay, PB, Power on/off, Backup
IP Filtering	supported
<b>Storage/Backup</b>	
Storage Devices	4 internal SATA HDDs, 1 external eSATA I/F, 10/100/1000 Ethernet for Storage
File System	Proprietary file system, data-loss protection against power-failure
Capacity	Max 16TB with SATA, Max 64TB with cascaded NVS04R
Backup type	multi-channel or single channel avi file
Backup device	internal CD/DVD or USB drive(2 port)
S.M.A.R.T.	Temperature and Health
<b>Serial &amp; I/O</b>	
Serial port	1 RS-232C, 2 RS-485
Sensor input	4 dry-contact
Relay output	4 relay
<b>Controller</b>	
Device	Front panel, IR remote, Joystick KBD, Mouse
<b>Software</b>	
WebViewer	Monitoring / Playback
Mobile Viewer	Monitoring with PTZ, iPhone & BB supported
CMS	Control Center Standard, max 1000 clients
SDK	ActiveX(COM) SDK
<b>Environmental &amp; Physical</b>	
Dimension	445(W) x 388(D) x 88(H)
Operating temperature	Operating: 41 ~ 113 degrees F.
Power	AC free volt (100 ~ 240VAC)
Power consumption	Max. 75W Typical 50W(TBD)

### HVRM-HD800M / HVRM-HD1600M

<b>Video input</b>	
Video input standard	HD-SDI SMPTE 292M
Connectors	8 ch HD-SDI inputs BNC connector
<b>Main Video output</b>	
Vout	HDMI / VGA 1,4,9 mode (16 mode for HVRM-HD1600M) User defined sequence / alarm pop-up 1920x1080p at HDMI / VGA port
<b>Recording</b>	
Compression	H.264 / JPEG
Resolution	1920*1080, 1280*720
Rate	120 fps at 1080p 240 fps at 720p
Quality	5 levels
Mode	Manual & Event / Schedule & Event
Schedule	24hrs / 7day

<b>Playback</b>	Instant playback / Search
Mode	Instant playback / Search
Speed	60 fps at 1080p 120 fps at 720p
Search Type	Time, Calender, Event, Thumbnail
Block Playback	24 hours ~ 31days
<b>Event &amp; Alarm</b>	
Event source	MD, Sensor, Text
Event check schedule	24hrs / 7day
Event Action	Recording, Relay, E-mail, Buzzer, Pop-up, Warning Message, PTZ preset
MD Area	22x15
Sensor input	dry contact (N.O. or N.C. selectable)
Text input	POS/ATM support, AVE VSI Pro/Hydra support
<b>System Alarm</b>	
Alarm source	HDD fail, HDD almost full, Fan fail, Pwd fail, WRS fail
Alarm action	Warning message, buzzer, e-mail, relay
<b>Audio</b>	
Input/output	4 RCA input, 1R CA output
Compression	16KHz, 16bit sampling ADPCM
Direction	Both
<b>PTZ</b>	
Protocols	32 models including Bosch, Pelco, Sony, Merit-lilin, Honeywell
<b>Network</b>	
Interface	1 10/100 Ethernet
Type	Fixed IP, Floating IP, xDSL
WRS	Supported
Bandwidth Limit	Supported
NTP	Server/Client/Both
Users	10 monitoring, 2 playback
Streaming	1 H.264 same as recording 1 additional H.264 smaller than recording 1 JPEG for e-mail sending or mobile
<b>Security</b>	
User Level	1 admin, 10 users
User privilege	Menu, PTZ, Relay, PB, Power on/off, Backup

IP Filtering	Supported
<b>Storage/Backup</b>	
Storage Devices	4 internal SATA HDDs, 1 external eSATA I/F, 10/100/1000 Ethernet for Storage
File System	Proprietary file system, data-loss protection against power-failure
Capacity	Max 16TB with SATA, Max 64TB with cascaded NVS04R
Backup type	multi-channel or single channel avi file
Backup device	internal CD/DVD or USB drive(2 port)
S.M.A.R.T.	Temperature and Health
<b>Serial &amp; I/O</b>	
Serial port	1 RS-232C, 2 RS-485
Sensor input	4 dry-contact
Relay output	4 relay
<b>Controller</b>	
Device	Front panel, IR remote, Joystick KBD, Mouse
<b>Software</b>	
WebViewer	Monitoring / Playback
Mobile Viewer	Monitoring with PTZ, iPhone & BB supported
CMS	Control Center Standard, max 1000 clients
SDK	ActiveX(COM) SDK
<b>Environmental &amp; Physical</b>	
Dimension	445(W) x 388(D) x 88(H)
Operating temperature	Operating: 41 ~ 113 degrees F.
Power	AC free volt (100 ~ 240VAC)
Power consumption	Max. 75W Typical 50W(TBD)

# Product Dimension

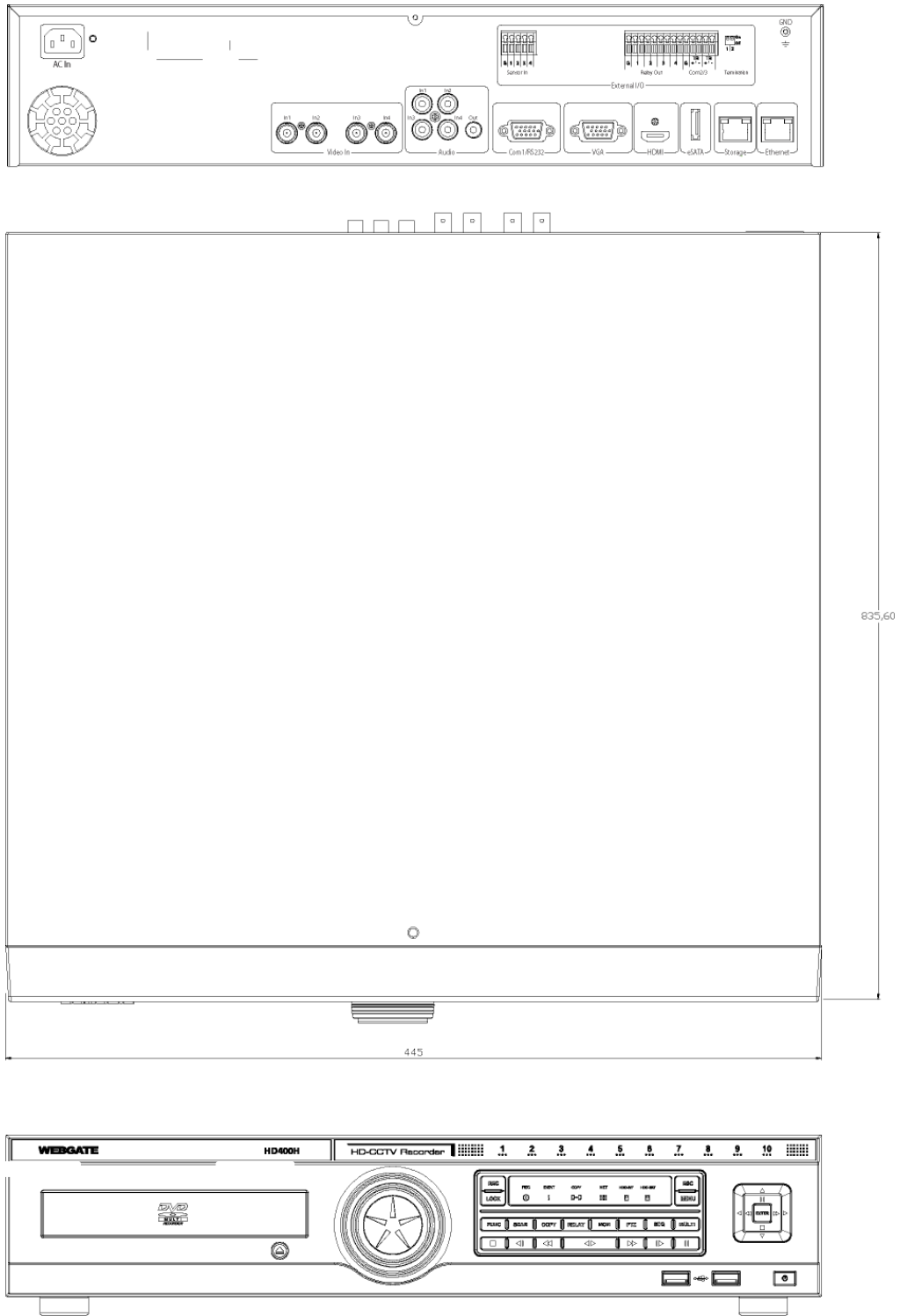

## Open Source License Report on the Product

---

The software included in this product contains copyrighted software that is licensed under the GPL/LGPL. You may obtain the complete Corresponding Source code from us for a period of three years after our last shipment of this product by sending email to [mycctv.manager@gmail.com](mailto:mycctv.manager@gmail.com).

If you want to obtain the complete Corresponding Source code in the physical medium such as CD-ROM, the cost of physically performing source distribution might be charged.

GPL Software : busybox, boa, CyaSSL, dosfstools, linux kernel, rp-pppoe, cdrtools, dvd+rw-tools, dhcpcd, iproute2, smartmontools

LGPL/GPL with exceptions : glibc, libgcc, libstdc++, FFMpeg, ftplib

Apache License : WenQuanYi Micro Hei

Copyright (c) 2007, Google Corp.; Copyright (c) 2008,2009 WenQuanYi Board of Trustees and Qianqian Fang.

Apache License : Apache Commons

<http://commons.apache.org>

BSD License : ash, miniupnpc, telnet-server, YUI Library, ppp

Freetype License : freetype2

Portions of this software included in this product are copyright (C) 2010 The FreeType Project

([www.freetype.org](http://www.freetype.org)). All rights reserved.

IJG License : JPEG

The software included in this product is based in part on the work of the Independent JPEG Group.

MIT License : c-ares, curl, liboauth, jcodec

OpenSSL License : OpenSSL

SIL Open Font License : Arimo

Copyright (c) 2010 Google Corporation.

This Font Software is licensed under the SIL Open Font License, Version 1.1.

This license is copied in this manual, and is also available with a FAQ at: <http://scripts.sil.org/OFL>

7.5.12



### **7.5.13 GNU GENERAL PUBLIC LICENSE**

Version 2, June 1991

Copyright (C) 1989, 1991 Free Software Foundation, Inc.  
51 Franklin Street, Fifth Floor, Boston, MA 02110-1301, USA

Everyone is permitted to copy and distribute verbatim copies of this license document, but changing it is not allowed.

#### **7.5.14 Preamble**

The licenses for most software are designed to take away your freedom to share and change it. By contrast, the GNU General Public License is intended to guarantee your freedom to share and change free software--to make sure the software is free for all its users. This General Public License applies to most of the Free Software Foundation's software and to any other program whose authors commit to using it. (Some other Free Software Foundation software is covered by the GNU Lesser General Public License instead.) You can apply it to your programs, too.

When we speak of free software, we are referring to freedom, not price. Our General Public Licenses are designed to make sure that you have the freedom to distribute copies of free software (and charge for this service if you wish), that you receive source code or can get it if you want it, that you can change the software or use pieces of it in new free programs; and that you know you can do these things.

To protect your rights, we need to make restrictions that forbid anyone to deny you these rights or to ask you to surrender the rights. These restrictions translate to certain responsibilities for you if you distribute copies of the software, or if you modify it.

For example, if you distribute copies of such a program, whether gratis or for a fee, you must give the recipients all the rights that you have. You must make sure that they, too, receive or can get the source code. And you must show them these terms so they know their rights.

We protect your rights with two steps: (1) copyright the software, and (2) offer you this license which gives you legal permission to copy, distribute and/or modify the software.

Also, for each author's protection and ours, we want to make certain that everyone understands that there is no warranty for this free software. If the software is modified by someone else and passed

on, we want its recipients to know that what they have is not the original, so that any problems introduced by others will not reflect on the original authors' reputations.

Finally, any free program is threatened constantly by software patents. We wish to avoid the danger that redistributors of a free program will individually obtain patent licenses, in effect making the program proprietary. To prevent this, we have made it clear that any patent must be licensed for everyone's free use or not licensed at all.

The precise terms and conditions for copying, distribution and modification follow.

### **7.5.15 TERMS AND CONDITIONS FOR COPYING, DISTRIBUTION AND MODIFICATION**

**0.** This License applies to any program or other work which contains a notice placed by the copyright holder saying it may be distributed under the terms of this General Public License. The "Program", below, refers to any such program or work, and a "work based on the Program" means either the Program or any derivative work under copyright law: that is to say, a work containing the Program or a portion of it, either verbatim or with modifications and/or translated into another language. (Hereinafter, translation is included without limitation in the term "modification".) Each licensee is addressed as "you".

Activities other than copying, distribution and modification are not covered by this License; they are outside its scope. The act of running the Program is not restricted, and the output from the Program is covered only if its contents constitute a work based on the Program (independent of having been made by running the Program). Whether that is true depends on what the Program does.

**1.** You may copy and distribute verbatim copies of the Program's source code as you receive it, in any medium, provided that you conspicuously and appropriately publish on each copy an appropriate copyright notice and disclaimer of warranty; keep intact all the notices that refer to this License and to the absence of any warranty; and give any other recipients of the Program a copy of this License along with the Program.

You may charge a fee for the physical act of transferring a copy, and you may at your option offer warranty protection in exchange for a fee.

**2.** You may modify your copy or copies of the Program or any portion of it, thus forming a work based on the Program, and copy and distribute such modifications or work under the terms of Section 1 above, provided that you also meet all of these conditions:

- a) You must cause the modified files to carry prominent notices stating that you changed the files and the date of any change.
- b) You must cause any work that you distribute or publish, that in whole or in part contains or is derived from the Program or any part thereof, to be licensed as a whole at no charge to all third parties under the terms of this License.
- c) If the modified program normally reads commands interactively when run, you must cause it, when started running for such interactive use in the most ordinary way, to print or display an announcement including an appropriate copyright notice and a notice that there is no warranty (or else, saying that you provide a warranty) and that users may redistribute the program under these conditions, and telling the user how to view a copy of this License. (Exception: if the Program itself is interactive but does not normally print such an announcement, your work based on the Program is not required to print an announcement.)

These requirements apply to the modified work as a whole. If identifiable sections of that work are not derived from the Program, and can be reasonably considered independent and separate works in themselves, then this License, and its terms, do not apply to those sections when you distribute them as separate works. But when you distribute the same sections as part of a whole which is a work based on the Program, the distribution of the whole must be on the terms of this License, whose permissions for other licensees extend to the entire whole, and thus to each and every part regardless of who wrote it.

Thus, it is not the intent of this section to claim rights or contest your rights to work written entirely by you; rather, the intent is to exercise the right to control the distribution of derivative or collective works based on the Program.

In addition, mere aggregation of another work not based on the Program with the Program (or with a work based on the Program) on a volume of a storage or distribution medium does not bring the other work under the scope of this License.

**3.** You may copy and distribute the Program (or a work based on it, under Section 2) in object code or executable form under the terms of Sections 1 and 2 above provided that you also do one of the following:

- a) Accompany it with the complete corresponding machine-readable source code, which must be distributed under the terms of Sections 1 and 2 above on a medium customarily used for software

interchange; or,

**b)** Accompany it with a written offer, valid for at least three years, to give any third party, for a charge no more than your cost of physically performing source distribution, a complete machine-readable copy of the corresponding source code, to be distributed under the terms of Sections 1 and 2 above on a medium customarily used for software interchange; or,

**c)** Accompany it with the information you received as to the offer to distribute corresponding source code. (This alternative is allowed only for noncommercial distribution and only if you received the program in object code or executable form with such an offer, in accord with Subsection b above.)

The source code for a work means the preferred form of the work for making modifications to it. For an executable work, complete source code means all the source code for all modules it contains, plus any associated interface definition files, plus the scripts used to control compilation and installation of the executable. However, as a special exception, the source code distributed need not include anything that is normally distributed (in either source or binary form) with the major components (compiler, kernel, and so on) of the operating system on which the executable runs, unless that component itself accompanies the executable.

If distribution of executable or object code is made by offering access to copy from a designated place, then offering equivalent access to copy the source code from the same place counts as distribution of the source code, even though third parties are not compelled to copy the source along with the object code.

**4.** You may not copy, modify, sublicense, or distribute the Program except as expressly provided under this License. Any attempt otherwise to copy, modify, sublicense or distribute the Program is void, and will automatically terminate your rights under this License. However, parties who have received copies, or rights, from you under this License will not have their licenses terminated so long as such parties remain in full compliance.

**5.** You are not required to accept this License, since you have not signed it. However, nothing else grants you permission to modify or distribute the Program or its derivative works. These actions are prohibited by law if you do not accept this License. Therefore, by modifying or distributing the Program (or any work based on the Program), you indicate your acceptance of this License to do so, and all its terms and conditions for copying, distributing or modifying the Program or works based on it.

**6.** Each time you redistribute the Program (or any work based on the Program), the recipient automatically receives a license from the original licensor to copy, distribute or modify the Program subject to these terms and conditions. You may not impose any further restrictions on the recipients'

exercise of the rights granted herein. You are not responsible for enforcing compliance by third parties to this License.

**7.** If, as a consequence of a court judgment or allegation of patent infringement or for any other reason (not limited to patent issues), conditions are imposed on you (whether by court order, agreement or otherwise) that contradict the conditions of this License, they do not excuse you from the conditions of this License. If you cannot distribute so as to satisfy simultaneously your obligations under this License and any other pertinent obligations, then as a consequence you may not distribute the Program at all. For example, if a patent license would not permit royalty-free redistribution of the Program by all those who receive copies directly or indirectly through you, then the only way you could satisfy both it and this License would be to refrain entirely from distribution of the Program.

If any portion of this section is held invalid or unenforceable under any particular circumstance, the balance of the section is intended to apply and the section as a whole is intended to apply in other circumstances.

It is not the purpose of this section to induce you to infringe any patents or other property right claims or to contest validity of any such claims; this section has the sole purpose of protecting the integrity of the free software distribution system, which is implemented by public license practices. Many people have made generous contributions to the wide range of software distributed through that system in reliance on consistent application of that system; it is up to the author/donor to decide if he or she is willing to distribute software through any other system and a licensee cannot impose that choice.

This section is intended to make thoroughly clear what is believed to be a consequence of the rest of this License.

**8.** If the distribution and/or use of the Program is restricted in certain countries either by patents or by copyrighted interfaces, the original copyright holder who places the Program under this License may add an explicit geographical distribution limitation excluding those countries, so that distribution is permitted only in or among countries not thus excluded. In such case, this License incorporates the limitation as if written in the body of this License.

**9.** The Free Software Foundation may publish revised and/or new versions of the General Public License from time to time. Such new versions will be similar in spirit to the present version, but may differ in detail to address new problems or concerns.

Each version is given a distinguishing version number. If the Program specifies a version number of this License which applies to it and "any later version", you have the option of following the terms and conditions either of that version or of any later version published by the Free Software Foundation. If the Program does not specify a version number of this License, you may choose any version ever published by the Free Software Foundation.

**10.** If you wish to incorporate parts of the Program into other free programs whose distribution conditions are different, write to the author to ask for permission. For software which is copyrighted by the Free Software Foundation, write to the Free Software Foundation; we sometimes make exceptions for this. Our decision will be guided by the two goals of preserving the free status of all derivatives of our free software and of promoting the sharing and reuse of software generally.

## **NO WARRANTY**

**11.** BECAUSE THE PROGRAM IS LICENSED FREE OF CHARGE, THERE IS NO WARRANTY FOR THE PROGRAM, TO THE EXTENT PERMITTED BY APPLICABLE LAW. EXCEPT WHEN OTHERWISE STATED IN WRITING THE COPYRIGHT HOLDERS AND/OR OTHER PARTIES PROVIDE THE PROGRAM "AS IS" WITHOUT WARRANTY OF ANY KIND, EITHER EXPRESSED OR IMPLIED, INCLUDING, BUT NOT LIMITED TO, THE IMPLIED WARRANTIES OF MERCHANTABILITY AND FITNESS FOR A PARTICULAR PURPOSE. THE ENTIRE RISK AS TO THE QUALITY AND PERFORMANCE OF THE PROGRAM IS WITH YOU. SHOULD THE PROGRAM PROVE DEFECTIVE, YOU ASSUME THE COST OF ALL NECESSARY SERVICING, REPAIR OR CORRECTION.

**12.** IN NO EVENT UNLESS REQUIRED BY APPLICABLE LAW OR AGREED TO IN WRITING WILL ANY COPYRIGHT HOLDER, OR ANY OTHER PARTY WHO MAY MODIFY AND/OR REDISTRIBUTE THE PROGRAM AS PERMITTED ABOVE, BE LIABLE TO YOU FOR DAMAGES, INCLUDING ANY GENERAL, SPECIAL, INCIDENTAL OR CONSEQUENTIAL DAMAGES ARISING OUT OF THE USE OR INABILITY TO USE THE PROGRAM (INCLUDING BUT NOT LIMITED TO LOSS OF DATA OR DATA BEING RENDERED INACCURATE OR LOSSES SUSTAINED BY YOU OR THIRD PARTIES OR A FAILURE OF THE PROGRAM TO OPERATE WITH ANY OTHER PROGRAMS), EVEN IF SUCH HOLDER OR OTHER PARTY HAS BEEN ADVISED OF THE POSSIBILITY OF SUCH DAMAGES.

## **7.5.16 END OF TERMS AND CONDITIONS**

### **7.5.17 How to Apply These Terms to Your New Programs**

If you develop a new program, and you want it to be of the greatest possible use to the public, the best way to achieve this is to make it free software which everyone can redistribute and change under these terms.

To do so, attach the following notices to the program. It is safest to attach them to the start of each source file to most effectively convey the exclusion of warranty; and each file should have at least the "copyright" line and a pointer to where the full notice is found.

*one line to give the program's name and an idea of what it does.*

Copyright (C) *yyyy name of author*

This program is free software; you can redistribute it and/or modify it under the terms of the GNU General Public License as published by the Free Software Foundation; either version 2 of the License, or (at your option) any later version.

This program is distributed in the hope that it will be useful, but WITHOUT ANY WARRANTY; without even the implied warranty of MERCHANTABILITY or FITNESS FOR A PARTICULAR PURPOSE. See the GNU General Public License for more details.

You should have received a copy of the GNU General Public License along with this program; if not, write to the Free Software Foundation, Inc., 51 Franklin Street, Fifth Floor, Boston, MA 02110-1301, USA.

Also add information on how to contact you by electronic and paper mail.

If the program is interactive, make it output a short notice like this when it starts in an interactive mode:

Gnomovision version 69, Copyright (C) *year name of author*

Gnomovision comes with ABSOLUTELY NO WARRANTY; for details

type `show w'. This is free software, and you are welcome

to redistribute it under certain conditions; type `show c`  
for details.

The hypothetical commands `show w` and `show c` should show the appropriate parts of the General Public License. Of course, the commands you use may be called something other than `show w` and `show c`; they could even be mouse-clicks or menu items--whatever suits your program.

You should also get your employer (if you work as a programmer) or your school, if any, to sign a "copyright disclaimer" for the program, if necessary. Here is a sample; alter the names:

Yoyodyne, Inc., hereby disclaims all copyright  
interest in the program `Gnomovision`  
(which makes passes at compilers) written  
by James Hacker.

*signature of Ty Coon*, 1 April 1989

Ty Coon, President of Vice

This General Public License does not permit incorporating your program into proprietary programs. If your program is a subroutine library, you may consider it more useful to permit linking proprietary applications with the library. If this is what you want to do, use the [GNU Lesser General Public License](#) instead of this License.

## **7.5.18 GNU GENERAL PUBLIC LICENSE**

Version 3, 29 June 2007

Copyright © 2007 Free Software Foundation, Inc. <<http://fsf.org/>>

Everyone is permitted to copy and distribute verbatim copies of this license document, but changing it is not allowed.

### **7.5.19 Preamble**

The GNU General Public License is a free, copyleft license for software and other kinds of works.



The licenses for most software and other practical works are designed to take away your freedom to share and change the works. By contrast, the GNU General Public License is intended to guarantee your freedom to share and change all versions of a program--to make sure it remains free software for all its users. We, the Free Software Foundation, use the GNU General Public License for most of our software; it applies also to any other work released this way by its authors. You can apply it to your programs, too.

When we speak of free software, we are referring to freedom, not price. Our General Public Licenses are designed to make sure that you have the freedom to distribute copies of free software (and charge for them if you wish), that you receive source code or can get it if you want it, that you can change the software or use pieces of it in new free programs, and that you know you can do these things.

To protect your rights, we need to prevent others from denying you these rights or asking you to surrender the rights. Therefore, you have certain responsibilities if you distribute copies of the software, or if you modify it: responsibilities to respect the freedom of others.

For example, if you distribute copies of such a program, whether gratis or for a fee, you must pass on to the recipients the same freedoms that you received. You must make sure that they, too, receive or can get the source code. And you must show them these terms so they know their rights.

Developers that use the GNU GPL protect your rights with two steps: (1) assert copyright on the software, and (2) offer you this License giving you legal permission to copy, distribute and/or modify it.

For the developers' and authors' protection, the GPL clearly explains that there is no warranty for this free software. For both users' and authors' sake, the GPL requires that modified versions be marked as changed, so that their problems will not be attributed erroneously to authors of previous versions.

Some devices are designed to deny users access to install or run modified versions of the software inside them, although the manufacturer can do so. This is fundamentally incompatible with the aim of protecting users' freedom to change the software. The systematic pattern of such abuse occurs in the area of products for individuals to use, which is precisely where it is most unacceptable.

Therefore, we have designed this version of the GPL to prohibit the practice for those products. If such problems arise substantially in other domains, we stand ready to extend this provision to those domains in future versions of the GPL, as needed to protect the freedom of users.

Finally, every program is threatened constantly by software patents. States should not allow patents to restrict development and use of software on general-purpose computers, but in those that do, we wish to avoid the special danger that patents applied to a free program could make it effectively proprietary. To prevent this, the GPL assures that patents cannot be used to render the program non-free.

The precise terms and conditions for copying, distribution and modification follow.

## **7.5.20 TERMS AND CONDITIONS**

### **1.2.3.1 0. Definitions.**

"This License" refers to version 3 of the GNU General Public License.

"Copyright" also means copyright-like laws that apply to other kinds of works, such as semiconductor masks.

"The Program" refers to any copyrightable work licensed under this License. Each licensee is addressed as "you". "Licensees" and "recipients" may be individuals or organizations.

To "modify" a work means to copy from or adapt all or part of the work in a fashion requiring copyright permission, other than the making of an exact copy. The resulting work is called a "modified version" of the earlier work or a work "based on" the earlier work.

A "covered work" means either the unmodified Program or a work based on the Program.

To "propagate" a work means to do anything with it that, without permission, would make you directly or secondarily liable for infringement under applicable copyright law, except executing it on a computer or modifying a private copy. Propagation includes copying, distribution (with or without modification), making available to the public, and in some countries other activities as well.

To "convey" a work means any kind of propagation that enables other parties to make or receive copies. Mere interaction with a user through a computer network, with no transfer of a copy, is not conveying.

An interactive user interface displays "Appropriate Legal Notices" to the extent that it includes a convenient and prominently visible feature that (1) displays an appropriate copyright notice, and (2) tells the user that there is no warranty for the work (except to the extent that warranties are

provided), that licensees may convey the work under this License, and how to view a copy of this License. If the interface presents a list of user commands or options, such as a menu, a prominent item in the list meets this criterion.

### 1.2.3.2 1. Source Code.

The "source code" for a work means the preferred form of the work for making modifications to it. "Object code" means any non-source form of a work.

A "Standard Interface" means an interface that either is an official standard defined by a recognized standards body, or, in the case of interfaces specified for a particular programming language, one that is widely used among developers working in that language.

The "System Libraries" of an executable work include anything, other than the work as a whole, that (a) is included in the normal form of packaging a Major Component, but which is not part of that Major Component, and (b) serves only to enable use of the work with that Major Component, or to implement a Standard Interface for which an implementation is available to the public in source code form. A "Major Component", in this context, means a major essential component (kernel, window system, and so on) of the specific operating system (if any) on which the executable work runs, or a compiler used to produce the work, or an object code interpreter used to run it.

The "Corresponding Source" for a work in object code form means all the source code needed to generate, install, and (for an executable work) run the object code and to modify the work, including scripts to control those activities. However, it does not include the work's System Libraries, or general-purpose tools or generally available free programs which are used unmodified in performing those activities but which are not part of the work. For example, Corresponding Source includes interface definition files associated with source files for the work, and the source code for shared libraries and dynamically linked subprograms that the work is specifically designed to require, such as by intimate data communication or control flow between those subprograms and other parts of the work.

The Corresponding Source need not include anything that users can regenerate automatically from other parts of the Corresponding Source.

The Corresponding Source for a work in source code form is that same work.

**1.2.3.3 2. Basic Permissions.**

All rights granted under this License are granted for the term of copyright on the Program, and are irrevocable provided the stated conditions are met. This License explicitly affirms your unlimited permission to run the unmodified Program. The output from running a covered work is covered by this License only if the output, given its content, constitutes a covered work. This License acknowledges your rights of fair use or other equivalent, as provided by copyright law.

You may make, run and propagate covered works that you do not convey, without conditions so long as your license otherwise remains in force. You may convey covered works to others for the sole purpose of having them make modifications exclusively for you, or provide you with facilities for running those works, provided that you comply with the terms of this License in conveying all material for which you do not control copyright. Those thus making or running the covered works for you must do so exclusively on your behalf, under your direction and control, on terms that prohibit them from making any copies of your copyrighted material outside their relationship with you.

Conveying under any other circumstances is permitted solely under the conditions stated below. Sublicensing is not allowed; section 10 makes it unnecessary.

**1.2.3.4 3. Protecting Users' Legal Rights From Anti-Circumvention Law.**

No covered work shall be deemed part of an effective technological measure under any applicable law fulfilling obligations under article 11 of the WIPO copyright treaty adopted on 20 December 1996, or similar laws prohibiting or restricting circumvention of such measures.

When you convey a covered work, you waive any legal power to forbid circumvention of technological measures to the extent such circumvention is effected by exercising rights under this License with respect to the covered work, and you disclaim any intention to limit operation or modification of the work as a means of enforcing, against the work's users, your or third parties' legal rights to forbid circumvention of technological measures.

**1.2.3.5 4. Conveying Verbatim Copies.**

You may convey verbatim copies of the Program's source code as you receive it, in any medium, provided that you conspicuously and appropriately publish on each copy an appropriate copyright notice; keep intact all notices stating that this License and any non-permissive terms added in accord with section 7 apply to the code; keep intact all notices of the absence of any warranty; and give all recipients a copy of this License along with the Program.

You may charge any price or no price for each copy that you convey, and you may offer support or warranty protection for a fee.

### **1.2.3.6 5. Conveying Modified Source Versions.**

You may convey a work based on the Program, or the modifications to produce it from the Program, in the form of source code under the terms of section 4, provided that you also meet all of these conditions:

- a) The work must carry prominent notices stating that you modified it, and giving a relevant date.
- b) The work must carry prominent notices stating that it is released under this License and any conditions added under section 7. This requirement modifies the requirement in section 4 to “keep intact all notices”.
- c) You must license the entire work, as a whole, under this License to anyone who comes into possession of a copy. This License will therefore apply, along with any applicable section 7 additional terms, to the whole of the work, and all its parts, regardless of how they are packaged. This License gives no permission to license the work in any other way, but it does not invalidate such permission if you have separately received it.
- d) If the work has interactive user interfaces, each must display Appropriate Legal Notices; however, if the Program has interactive interfaces that do not display Appropriate Legal Notices, your work need not make them do so.

A compilation of a covered work with other separate and independent works, which are not by their nature extensions of the covered work, and which are not combined with it such as to form a larger program, in or on a volume of a storage or distribution medium, is called an “aggregate” if the compilation and its resulting copyright are not used to limit the access or legal rights of the compilation's users beyond what the individual works permit. Inclusion of a covered work in an aggregate does not cause this License to apply to the other parts of the aggregate.

### **1.2.3.7 6. Conveying Non-Source Forms.**

You may convey a covered work in object code form under the terms of sections 4 and 5, provided that you also convey the machine-readable Corresponding Source under the terms of this License, in one of these ways:

- a) Convey the object code in, or embodied in, a physical product (including a physical distribution medium), accompanied by the Corresponding Source fixed on a durable physical medium customarily used for software interchange.
- b) Convey the object code in, or embodied in, a physical product (including a physical distribution medium), accompanied by a written offer, valid for at least three years and valid for as long as you offer

spare parts or customer support for that product model, to give anyone who possesses the object code either (1) a copy of the Corresponding Source for all the software in the product that is covered by this License, on a durable physical medium customarily used for software interchange, for a price no more than your reasonable cost of physically performing this conveying of source, or (2) access to copy the Corresponding Source from a network server at no charge.

- c) Convey individual copies of the object code with a copy of the written offer to provide the Corresponding Source. This alternative is allowed only occasionally and noncommercially, and only if you received the object code with such an offer, in accord with subsection 6b.
- d) Convey the object code by offering access from a designated place (gratis or for a charge), and offer equivalent access to the Corresponding Source in the same way through the same place at no further charge. You need not require recipients to copy the Corresponding Source along with the object code. If the place to copy the object code is a network server, the Corresponding Source may be on a different server (operated by you or a third party) that supports equivalent copying facilities, provided you maintain clear directions next to the object code saying where to find the Corresponding Source. Regardless of what server hosts the Corresponding Source, you remain obligated to ensure that it is available for as long as needed to satisfy these requirements.
- e) Convey the object code using peer-to-peer transmission, provided you inform other peers where the object code and Corresponding Source of the work are being offered to the general public at no charge under subsection 6d.

A separable portion of the object code, whose source code is excluded from the Corresponding Source as a System Library, need not be included in conveying the object code work.

A "User Product" is either (1) a "consumer product", which means any tangible personal property which is normally used for personal, family, or household purposes, or (2) anything designed or sold for incorporation into a dwelling. In determining whether a product is a consumer product, doubtful cases shall be resolved in favor of coverage. For a particular product received by a particular user, "normally used" refers to a typical or common use of that class of product, regardless of the status of the particular user or of the way in which the particular user actually uses, or expects or is expected to use, the product. A product is a consumer product regardless of whether the product has substantial commercial, industrial or non-consumer uses, unless such uses represent the only significant mode of use of the product.

"Installation Information" for a User Product means any methods, procedures, authorization keys, or other information required to install and execute modified versions of a covered work in that User Product from a modified version of its Corresponding Source. The information must suffice to ensure that the continued functioning of the modified object code is in no case prevented or interfered with solely because modification has been made.

If you convey an object code work under this section in, or with, or specifically for use in, a User Product, and the conveying occurs as part of a transaction in which the right of possession and use of the User Product is transferred to the recipient in perpetuity or for a fixed term (regardless of how the transaction is characterized), the Corresponding Source conveyed under this section must be accompanied by the Installation Information. But this requirement does not apply if neither you nor any third party retains the ability to install modified object code on the User Product (for example, the work has been installed in ROM).

The requirement to provide Installation Information does not include a requirement to continue to provide support service, warranty, or updates for a work that has been modified or installed by the recipient, or for the User Product in which it has been modified or installed. Access to a network may be denied when the modification itself materially and adversely affects the operation of the network or violates the rules and protocols for communication across the network.

Corresponding Source conveyed, and Installation Information provided, in accord with this section must be in a format that is publicly documented (and with an implementation available to the public in source code form), and must require no special password or key for unpacking, reading or copying.

### 1.2.3.8 7. Additional Terms.

"Additional permissions" are terms that supplement the terms of this License by making exceptions from one or more of its conditions. Additional permissions that are applicable to the entire Program shall be treated as though they were included in this License, to the extent that they are valid under applicable law. If additional permissions apply only to part of the Program, that part may be used separately under those permissions, but the entire Program remains governed by this License without regard to the additional permissions.

When you convey a copy of a covered work, you may at your option remove any additional permissions from that copy, or from any part of it. (Additional permissions may be written to require their own removal in certain cases when you modify the work.) You may place additional permissions on material, added by you to a covered work, for which you have or can give appropriate copyright permission.

Notwithstanding any other provision of this License, for material you add to a covered work, you may (if authorized by the copyright holders of that material) supplement the terms of this License with terms:

- a) Disclaiming warranty or limiting liability differently from the terms of sections 15 and 16 of this License; or

- b) Requiring preservation of specified reasonable legal notices or author attributions in that material or in the Appropriate Legal Notices displayed by works containing it; or
- c) Prohibiting misrepresentation of the origin of that material, or requiring that modified versions of such material be marked in reasonable ways as different from the original version; or
- d) Limiting the use for publicity purposes of names of licensors or authors of the material; or
- e) Declining to grant rights under trademark law for use of some trade names, trademarks, or service marks; or
- f) Requiring indemnification of licensors and authors of that material by anyone who conveys the material (or modified versions of it) with contractual assumptions of liability to the recipient, for any liability that these contractual assumptions directly impose on those licensors and authors.

All other non-permissive additional terms are considered "further restrictions" within the meaning of section 10. If the Program as you received it, or any part of it, contains a notice stating that it is governed by this License along with a term that is a further restriction, you may remove that term. If a license document contains a further restriction but permits relicensing or conveying under this License, you may add to a covered work material governed by the terms of that license document, provided that the further restriction does not survive such relicensing or conveying.

If you add terms to a covered work in accord with this section, you must place, in the relevant source files, a statement of the additional terms that apply to those files, or a notice indicating where to find the applicable terms.

Additional terms, permissive or non-permissive, may be stated in the form of a separately written license, or stated as exceptions; the above requirements apply either way.

#### **1.2.3.9 8. Termination.**

You may not propagate or modify a covered work except as expressly provided under this License. Any attempt otherwise to propagate or modify it is void, and will automatically terminate your rights under this License (including any patent licenses granted under the third paragraph of section 11).

However, if you cease all violation of this License, then your license from a particular copyright holder is reinstated (a) provisionally, unless and until the copyright holder explicitly and finally terminates your license, and (b) permanently, if the copyright holder fails to notify you of the violation by some reasonable means prior to 60 days after the cessation.

Moreover, your license from a particular copyright holder is reinstated permanently if the copyright holder notifies you of the violation by some reasonable means, this is the first time you have



received notice of violation of this License (for any work) from that copyright holder, and you cure the violation prior to 30 days after your receipt of the notice.

Termination of your rights under this section does not terminate the licenses of parties who have received copies or rights from you under this License. If your rights have been terminated and not permanently reinstated, you do not qualify to receive new licenses for the same material under section 10.

### **1.2.3.10 9. Acceptance Not Required for Having Copies.**

You are not required to accept this License in order to receive or run a copy of the Program. Ancillary propagation of a covered work occurring solely as a consequence of using peer-to-peer transmission to receive a copy likewise does not require acceptance. However, nothing other than this License grants you permission to propagate or modify any covered work. These actions infringe copyright if you do not accept this License. Therefore, by modifying or propagating a covered work, you indicate your acceptance of this License to do so.

### **1.2.3.11 10. Automatic Licensing of Downstream Recipients.**

Each time you convey a covered work, the recipient automatically receives a license from the original licensors, to run, modify and propagate that work, subject to this License. You are not responsible for enforcing compliance by third parties with this License.

An "entity transaction" is a transaction transferring control of an organization, or substantially all assets of one, or subdividing an organization, or merging organizations. If propagation of a covered work results from an entity transaction, each party to that transaction who receives a copy of the work also receives whatever licenses to the work the party's predecessor in interest had or could give under the previous paragraph, plus a right to possession of the Corresponding Source of the work from the predecessor in interest, if the predecessor has it or can get it with reasonable efforts.

You may not impose any further restrictions on the exercise of the rights granted or affirmed under this License. For example, you may not impose a license fee, royalty, or other charge for exercise of rights granted under this License, and you may not initiate litigation (including a cross-claim or counterclaim in a lawsuit) alleging that any patent claim is infringed by making, using, selling, offering for sale, or importing the Program or any portion of it.

**1.2.3.12 11. Patents.**

A "contributor" is a copyright holder who authorizes use under this License of the Program or a work on which the Program is based. The work thus licensed is called the contributor's "contributor version".

A contributor's "essential patent claims" are all patent claims owned or controlled by the contributor, whether already acquired or hereafter acquired, that would be infringed by some manner, permitted by this License, of making, using, or selling its contributor version, but do not include claims that would be infringed only as a consequence of further modification of the contributor version. For purposes of this definition, "control" includes the right to grant patent sublicenses in a manner consistent with the requirements of this License.

Each contributor grants you a non-exclusive, worldwide, royalty-free patent license under the contributor's essential patent claims, to make, use, sell, offer for sale, import and otherwise run, modify and propagate the contents of its contributor version.

In the following three paragraphs, a "patent license" is any express agreement or commitment, however denominated, not to enforce a patent (such as an express permission to practice a patent or covenant not to sue for patent infringement). To "grant" such a patent license to a party means to make such an agreement or commitment not to enforce a patent against the party.

If you convey a covered work, knowingly relying on a patent license, and the Corresponding Source of the work is not available for anyone to copy, free of charge and under the terms of this License, through a publicly available network server or other readily accessible means, then you must either (1) cause the Corresponding Source to be so available, or (2) arrange to deprive yourself of the benefit of the patent license for this particular work, or (3) arrange, in a manner consistent with the requirements of this License, to extend the patent license to downstream recipients. "Knowingly relying" means you have actual knowledge that, but for the patent license, your conveying the covered work in a country, or your recipient's use of the covered work in a country, would infringe one or more identifiable patents in that country that you have reason to believe are valid.

If, pursuant to or in connection with a single transaction or arrangement, you convey, or propagate by procuring conveyance of, a covered work, and grant a patent license to some of the parties receiving the covered work authorizing them to use, propagate, modify or convey a specific copy of the covered work, then the patent license you grant is automatically extended to all recipients of the covered work and works based on it.

A patent license is "discriminatory" if it does not include within the scope of its coverage, prohibits the exercise of, or is conditioned on the non-exercise of one or more of the rights that are specifically granted under this License. You may not convey a covered work if you are a party to an arrangement with a third party that is in the business of distributing software, under which you make payment to the third party based on the extent of your activity of conveying the work, and under which the third party grants, to any of the parties who would receive the covered work from you, a discriminatory patent license (a) in connection with copies of the covered work conveyed by you (or copies made from those copies), or (b) primarily for and in connection with specific products or compilations that contain the covered work, unless you entered into that arrangement, or that patent license was granted, prior to 28 March 2007.

Nothing in this License shall be construed as excluding or limiting any implied license or other defenses to infringement that may otherwise be available to you under applicable patent law.

### **1.2.3.13 12. No Surrender of Others' Freedom.**

If conditions are imposed on you (whether by court order, agreement or otherwise) that contradict the conditions of this License, they do not excuse you from the conditions of this License. If you cannot convey a covered work so as to satisfy simultaneously your obligations under this License and any other pertinent obligations, then as a consequence you may not convey it at all. For example, if you agree to terms that obligate you to collect a royalty for further conveying from those to whom you convey the Program, the only way you could satisfy both those terms and this License would be to refrain entirely from conveying the Program.

### **1.2.3.14 13. Use with the GNU Affero General Public License.**

Notwithstanding any other provision of this License, you have permission to link or combine any covered work with a work licensed under version 3 of the GNU Affero General Public License into a single combined work, and to convey the resulting work. The terms of this License will continue to apply to the part which is the covered work, but the special requirements of the GNU Affero General Public License, section 13, concerning interaction through a network will apply to the combination as such.

### **1.2.3.15 14. Revised Versions of this License.**

The Free Software Foundation may publish revised and/or new versions of the GNU General Public License from time to time. Such new versions will be similar in spirit to the present version, but may differ in detail to address new problems or concerns.

Each version is given a distinguishing version number. If the Program specifies that a certain numbered version of the GNU General Public License "or any later version" applies to it, you have the option of following the terms and conditions either of that numbered version or of any later version published by the Free Software Foundation. If the Program does not specify a version number of the GNU General Public License, you may choose any version ever published by the Free Software Foundation.

If the Program specifies that a proxy can decide which future versions of the GNU General Public License can be used, that proxy's public statement of acceptance of a version permanently authorizes you to choose that version for the Program.

Later license versions may give you additional or different permissions. However, no additional obligations are imposed on any author or copyright holder as a result of your choosing to follow a later version.

**1.2.3.16 15. Disclaimer of Warranty.**

THERE IS NO WARRANTY FOR THE PROGRAM, TO THE EXTENT PERMITTED BY APPLICABLE LAW. EXCEPT WHEN OTHERWISE STATED IN WRITING THE COPYRIGHT HOLDERS AND/OR OTHER PARTIES PROVIDE THE PROGRAM "AS IS" WITHOUT WARRANTY OF ANY KIND, EITHER EXPRESSED OR IMPLIED, INCLUDING, BUT NOT LIMITED TO, THE IMPLIED WARRANTIES OF MERCHANTABILITY AND FITNESS FOR A PARTICULAR PURPOSE. THE ENTIRE RISK AS TO THE QUALITY AND PERFORMANCE OF THE PROGRAM IS WITH YOU. SHOULD THE PROGRAM PROVE DEFECTIVE, YOU ASSUME THE COST OF ALL NECESSARY SERVICING, REPAIR OR CORRECTION.

**1.2.3.17 16. Limitation of Liability.**

IN NO EVENT UNLESS REQUIRED BY APPLICABLE LAW OR AGREED TO IN WRITING WILL ANY COPYRIGHT HOLDER, OR ANY OTHER PARTY WHO MODIFIES AND/OR CONVEYS THE PROGRAM AS PERMITTED ABOVE, BE LIABLE TO YOU FOR DAMAGES, INCLUDING ANY GENERAL, SPECIAL, INCIDENTAL OR CONSEQUENTIAL DAMAGES ARISING OUT OF THE USE OR INABILITY TO USE THE PROGRAM (INCLUDING BUT NOT LIMITED TO LOSS OF DATA OR DATA BEING RENDERED INACCURATE OR LOSSES SUSTAINED BY YOU OR THIRD PARTIES OR A FAILURE OF THE PROGRAM TO OPERATE WITH ANY OTHER PROGRAMS), EVEN IF SUCH HOLDER OR OTHER PARTY HAS BEEN ADVISED OF THE POSSIBILITY OF SUCH DAMAGES.

### 1.2.3.18 17. Interpretation of Sections 15 and 16.

If the disclaimer of warranty and limitation of liability provided above cannot be given local legal effect according to their terms, reviewing courts shall apply local law that most closely approximates an absolute waiver of all civil liability in connection with the Program, unless a warranty or assumption of liability accompanies a copy of the Program in return for a fee.

END OF TERMS AND CONDITIONS

## 7.5.21 How to Apply These Terms to Your New Programs

If you develop a new program, and you want it to be of the greatest possible use to the public, the best way to achieve this is to make it free software which everyone can redistribute and change under these terms.

To do so, attach the following notices to the program. It is safest to attach them to the start of each source file to most effectively state the exclusion of warranty; and each file should have at least the "copyright" line and a pointer to where the full notice is found.

```
<one line to give the program's name and a brief idea of what it does.>  
Copyright (C) <year> <name of author>
```

```
This program is free software: you can redistribute it and/or modify  
it under the terms of the GNU General Public License as published by  
the Free Software Foundation, either version 3 of the License, or  
(at your option) any later version.
```

```
This program is distributed in the hope that it will be useful,  
but WITHOUT ANY WARRANTY; without even the implied warranty of  
MERCHANTABILITY or FITNESS FOR A PARTICULAR PURPOSE. See the  
GNU General Public License for more details.
```

```
You should have received a copy of the GNU General Public License  
along with this program. If not, see <http://www.gnu.org/licenses/>.
```

Also add information on how to contact you by electronic and paper mail.

If the program does terminal interaction, make it output a short notice like this when it starts in an interactive mode:

```
<program> Copyright (C) <year> <name of author>  
This program comes with ABSOLUTELY NO WARRANTY; for details type `show w'.  
This is free software, and you are welcome to redistribute it  
under certain conditions; type `show c' for details.
```

The hypothetical commands `show w' and `show c' should show the appropriate parts of the General Public License. Of course, your program's commands might be different; for a GUI interface, you would use an "about box".

You should also get your employer (if you work as a programmer) or school, if any, to sign a "copyright disclaimer" for the program, if necessary. For more information on this, and how to apply and follow the GNU GPL, see <<http://www.gnu.org/licenses/>>.

The GNU General Public License does not permit incorporating your program into proprietary programs. If your program is a subroutine library, you may consider it more useful to permit linking proprietary applications with the library. If this is what you want to do, use the GNU Lesser General Public License instead of this License. But first, please read <<http://www.gnu.org/philosophy/why-not-lgpl.html>>.

## **GNU LESSER GENERAL PUBLIC LICENSE**

Version 2.1, February 1999

Copyright (C) 1991, 1999 Free Software Foundation, Inc.

51 Franklin Street, Fifth Floor, Boston, MA 02110-1301 USA

Everyone is permitted to copy and distribute verbatim copies of this license document, but changing it is not allowed.

[This is the first released version of the Lesser GPL. It also counts as the successor of the GNU Library Public License, version 2, hence the version number 2.1.]

### **Preamble**

The licenses for most software are designed to take away your freedom to share and change it. By contrast, the GNU General Public Licenses are intended to guarantee your freedom to share and change free software--to make sure the software is free for all its users.

This license, the Lesser General Public License, applies to some specially designated software packages--typically libraries--of the Free Software Foundation and other authors who decide to use it. You can use it too, but we suggest you first think carefully about whether this license or the ordinary General Public License is the better strategy to use in any particular case, based on the explanations below.

When we speak of free software, we are referring to freedom of use, not price. Our General Public Licenses are designed to make sure that you have the freedom to distribute copies of free software (and charge for this service if you wish); that you receive source code or can get it if you want it; that you can change the software and use pieces of it in new free programs; and that you are informed that you can do these things.

To protect your rights, we need to make restrictions that forbid distributors to deny you these rights or to ask you to surrender these rights. These restrictions translate to certain responsibilities for you if you distribute copies of the library or if you modify it.

For example, if you distribute copies of the library, whether gratis or for a fee, you must give the recipients all the rights that we gave you. You must make sure that they, too, receive or can get the source code. If you link other code with the library, you must provide complete object files to the recipients, so that they can relink them with the library after making changes to the library and recompiling it. And you must show them these terms so they know their rights.

We protect your rights with a two-step method: (1) we copyright the library, and (2) we offer you this license, which gives you legal permission to copy, distribute and/or modify the library.

To protect each distributor, we want to make it very clear that there is no warranty for the free library. Also, if the library is modified by someone else and passed on, the recipients should know that what they have is not the original version, so that the original author's reputation will not be affected by problems that might be introduced by others.

Finally, software patents pose a constant threat to the existence of any free program. We wish to make sure that a company cannot effectively restrict the users of a free program by obtaining a restrictive license from a patent holder. Therefore, we insist that any patent license obtained for a version of the library must be consistent with the full freedom of use specified in this license.

Most GNU software, including some libraries, is covered by the ordinary GNU General Public License. This license, the GNU Lesser General Public License, applies to certain designated libraries, and is quite different from the

ordinary General Public License. We use this license for certain libraries in order to permit linking those libraries into non-free programs.

When a program is linked with a library, whether statically or using a shared library, the combination of the two is legally speaking a combined work, a derivative of the original library. The ordinary General Public License therefore permits such linking only if the entire combination fits its criteria of freedom. The Lesser General Public License permits more lax criteria for linking other code with the library.

We call this license the "Lesser" General Public License because it does Less to protect the user's freedom than the ordinary General Public License. It also provides other free software developers Less of an advantage over competing non-free programs. These disadvantages are the reason we use the ordinary General Public License for many libraries. However, the Lesser license provides advantages in certain special circumstances.

For example, on rare occasions, there may be a special need to encourage the widest possible use of a certain library, so that it becomes a de-facto standard. To achieve this, non-free programs must be allowed to use the library. A more frequent case is that a free library does the same job as widely used non-free libraries. In this case, there is little to gain by limiting the free library to free software only, so we use the Lesser General Public License.

In other cases, permission to use a particular library in non-free programs enables a greater number of people to use a large body of free software. For example, permission to use the GNU C Library in non-free programs enables many more people to use the whole GNU operating system, as well as its variant, the GNU/Linux operating system.

Although the Lesser General Public License is Less protective of the users' freedom, it does ensure that the user of a program that is linked with the Library has the freedom and the wherewithal to run that program using a modified version of the Library.

The precise terms and conditions for copying, distribution and modification follow. Pay close attention to the difference between a "work based on the library" and a "work that uses the library". The former contains code derived from the library, whereas the latter must be combined with the library in order to run.

### **TERMS AND CONDITIONS FOR COPYING, DISTRIBUTION AND MODIFICATION**

**0.** This License Agreement applies to any software library or other program which contains a notice placed by the copyright holder or other authorized party saying it may be distributed under the terms of this Lesser General Public License (also called "this License"). Each licensee is addressed as "you".

A "library" means a collection of software functions and/or data prepared so as to be conveniently linked with application programs (which use some of those functions and data) to form executables.



The "Library", below, refers to any such software library or work which has been distributed under these terms. A "work based on the Library" means either the Library or any derivative work under copyright law: that is to say, a work containing the Library or a portion of it, either verbatim or with modifications and/or translated straightforwardly into another language. (Hereinafter, translation is included without limitation in the term "modification".)

"Source code" for a work means the preferred form of the work for making modifications to it. For a library, complete source code means all the source code for all modules it contains, plus any associated interface definition files, plus the scripts used to control compilation and installation of the library.

Activities other than copying, distribution and modification are not covered by this License; they are outside its scope. The act of running a program using the Library is not restricted, and output from such a program is covered only if its contents constitute a work based on the Library (independent of the use of the Library in a tool for writing it). Whether that is true depends on what the Library does and what the program that uses the Library does.

**1.** You may copy and distribute verbatim copies of the Library's complete source code as you receive it, in any medium, provided that you conspicuously and appropriately publish on each copy an appropriate copyright notice and disclaimer of warranty; keep intact all the notices that refer to this License and to the absence of any warranty; and distribute a copy of this License along with the Library.

You may charge a fee for the physical act of transferring a copy, and you may at your option offer warranty protection in exchange for a fee.

**2.** You may modify your copy or copies of the Library or any portion of it, thus forming a work based on the Library, and copy and distribute such modifications or work under the terms of Section 1 above, provided that you also meet all of these conditions:

- **a)** The modified work must itself be a software library.
- **b)** You must cause the files modified to carry prominent notices stating that you changed the files and the date of any change.
- **c)** You must cause the whole of the work to be licensed at no charge to all third parties under the terms of this License.
- **d)** If a facility in the modified Library refers to a function or a table of data to be supplied by an application program that uses the facility, other than as an argument passed when the facility is invoked, then you must make a good faith effort to ensure that, in the event an application does not supply such function or table, the facility still operates, and performs whatever part of its purpose remains meaningful.

(For example, a function in a library to compute square roots has a purpose that is entirely well-defined independent of the application. Therefore, Subsection 2d requires that any application-supplied function or

table used by this function must be optional: if the application does not supply it, the square root function must still compute square roots.)

These requirements apply to the modified work as a whole. If identifiable sections of that work are not derived from the Library, and can be reasonably considered independent and separate works in themselves, then this License, and its terms, do not apply to those sections when you distribute them as separate works. But when you distribute the same sections as part of a whole which is a work based on the Library, the distribution of the whole must be on the terms of this License, whose permissions for other licensees extend to the entire whole, and thus to each and every part regardless of who wrote it.

Thus, it is not the intent of this section to claim rights or contest your rights to work written entirely by you; rather, the intent is to exercise the right to control the distribution of derivative or collective works based on the Library.

In addition, mere aggregation of another work not based on the Library with the Library (or with a work based on the Library) on a volume of a storage or distribution medium does not bring the other work under the scope of this License.

**3.** You may opt to apply the terms of the ordinary GNU General Public License instead of this License to a given copy of the Library. To do this, you must alter all the notices that refer to this License, so that they refer to the ordinary GNU General Public License, version 2, instead of to this License. (If a newer version than version 2 of the ordinary GNU General Public License has appeared, then you can specify that version instead if you wish.) Do not make any other change in these notices.

Once this change is made in a given copy, it is irreversible for that copy, so the ordinary GNU General Public License applies to all subsequent copies and derivative works made from that copy.

This option is useful when you wish to copy part of the code of the Library into a program that is not a library.

**4.** You may copy and distribute the Library (or a portion or derivative of it, under Section 2) in object code or executable form under the terms of Sections 1 and 2 above provided that you accompany it with the complete corresponding machine-readable source code, which must be distributed under the terms of Sections 1 and 2 above on a medium customarily used for software interchange.

If distribution of object code is made by offering access to copy from a designated place, then offering equivalent access to copy the source code from the same place satisfies the requirement to distribute the source code, even though third parties are not compelled to copy the source along with the object code.

5. A program that contains no derivative of any portion of the Library, but is designed to work with the Library by being compiled or linked with it, is called a "work that uses the Library". Such a work, in isolation, is not a derivative work of the Library, and therefore falls outside the scope of this License.

However, linking a "work that uses the Library" with the Library creates an executable that is a derivative of the Library (because it contains portions of the Library), rather than a "work that uses the library". The executable is therefore covered by this License. Section 6 states terms for distribution of such executables.

When a "work that uses the Library" uses material from a header file that is part of the Library, the object code for the work may be a derivative work of the Library even though the source code is not. Whether this is true is especially significant if the work can be linked without the Library, or if the work is itself a library. The threshold for this to be true is not precisely defined by law.

If such an object file uses only numerical parameters, data structure layouts and accessors, and small macros and small inline functions (ten lines or less in length), then the use of the object file is unrestricted, regardless of whether it is legally a derivative work. (Executables containing this object code plus portions of the Library will still fall under Section 6.)

Otherwise, if the work is a derivative of the Library, you may distribute the object code for the work under the terms of Section 6. Any executables containing that work also fall under Section 6, whether or not they are linked directly with the Library itself.

6. As an exception to the Sections above, you may also combine or link a "work that uses the Library" with the Library to produce a work containing portions of the Library, and distribute that work under terms of your choice, provided that the terms permit modification of the work for the customer's own use and reverse engineering for debugging such modifications.

You must give prominent notice with each copy of the work that the Library is used in it and that the Library and its use are covered by this License. You must supply a copy of this License. If the work during execution displays copyright notices, you must include the copyright notice for the Library among them, as well as a reference directing the user to the copy of this License. Also, you must do one of these things:

- **a)** Accompany the work with the complete corresponding machine-readable source code for the Library including whatever changes were used in the work (which must be distributed under Sections 1 and 2 above); and, if the work is an executable linked with the Library, with the complete machine-readable "work that uses the Library", as object code and/or source code, so that the user can modify the Library and then relink to produce a modified executable containing the modified Library. (It is understood that the user who changes the contents of definitions files in the Library will not necessarily be able to recompile the application to use the modified definitions.)

- **b)** Use a suitable shared library mechanism for linking with the Library. A suitable mechanism is one that (1) uses at run time a copy of the library already present on the user's computer system, rather than copying library functions into the executable, and (2) will operate properly with a modified version of the library, if the user installs one, as long as the modified version is interface-compatible with the version that the work was made with.
- **c)** Accompany the work with a written offer, valid for at least three years, to give the same user the materials specified in Subsection 6a, above, for a charge no more than the cost of performing this distribution.
- **d)** If distribution of the work is made by offering access to copy from a designated place, offer equivalent access to copy the above specified materials from the same place.
- **e)** Verify that the user has already received a copy of these materials or that you have already sent this user a copy.

For an executable, the required form of the "work that uses the Library" must include any data and utility programs needed for reproducing the executable from it. However, as a special exception, the materials to be distributed need not include anything that is normally distributed (in either source or binary form) with the major components (compiler, kernel, and so on) of the operating system on which the executable runs, unless that component itself accompanies the executable.

It may happen that this requirement contradicts the license restrictions of other proprietary libraries that do not normally accompany the operating system. Such a contradiction means you cannot use both them and the Library together in an executable that you distribute.

**7.** You may place library facilities that are a work based on the Library side-by-side in a single library together with other library facilities not covered by this License, and distribute such a combined library, provided that the separate distribution of the work based on the Library and of the other library facilities is otherwise permitted, and provided that you do these two things:

- **a)** Accompany the combined library with a copy of the same work based on the Library, uncombined with any other library facilities. This must be distributed under the terms of the Sections above.
- **b)** Give prominent notice with the combined library of the fact that part of it is a work based on the Library, and explaining where to find the accompanying uncombined form of the same work.

**8.** You may not copy, modify, sublicense, link with, or distribute the Library except as expressly provided under this License. Any attempt otherwise to copy, modify, sublicense, link with, or distribute the Library is void, and will automatically terminate your rights under this License. However, parties who have received copies, or rights, from you under this License will not have their licenses terminated so long as such parties remain in full compliance.

**9.** You are not required to accept this License, since you have not signed it. However, nothing else grants you permission to modify or distribute the Library or its derivative works. These actions are prohibited by law if you do not accept this License. Therefore, by modifying or distributing the Library (or any work based on the Library), you indicate your acceptance of this License to do so, and all its terms and conditions for copying, distributing or modifying the Library or works based on it.

**10.** Each time you redistribute the Library (or any work based on the Library), the recipient automatically receives a license from the original licensor to copy, distribute, link with or modify the Library subject to these terms and conditions. You may not impose any further restrictions on the recipients' exercise of the rights granted herein. You are not responsible for enforcing compliance by third parties with this License.

**11.** If, as a consequence of a court judgment or allegation of patent infringement or for any other reason (not limited to patent issues), conditions are imposed on you (whether by court order, agreement or otherwise) that contradict the conditions of this License, they do not excuse you from the conditions of this License. If you cannot distribute so as to satisfy simultaneously your obligations under this License and any other pertinent obligations, then as a consequence you may not distribute the Library at all. For example, if a patent license would not permit royalty-free redistribution of the Library by all those who receive copies directly or indirectly through you, then the only way you could satisfy both it and this License would be to refrain entirely from distribution of the Library.

If any portion of this section is held invalid or unenforceable under any particular circumstance, the balance of the section is intended to apply, and the section as a whole is intended to apply in other circumstances.

It is not the purpose of this section to induce you to infringe any patents or other property right claims or to contest validity of any such claims; this section has the sole purpose of protecting the integrity of the free software distribution system which is implemented by public license practices. Many people have made generous contributions to the wide range of software distributed through that system in reliance on consistent application of that system; it is up to the author/donor to decide if he or she is willing to distribute software through any other system and a licensee cannot impose that choice.

This section is intended to make thoroughly clear what is believed to be a consequence of the rest of this License.

**12.** If the distribution and/or use of the Library is restricted in certain countries either by patents or by copyrighted interfaces, the original copyright holder who places the Library under this License may add an explicit geographical distribution limitation excluding those countries, so that distribution is permitted only in or among countries not thus excluded. In such case, this License incorporates the limitation as if written in the body of this License.

**13.** The Free Software Foundation may publish revised and/or new versions of the Lesser General Public License from time to time. Such new versions will be similar in spirit to the present version, but may differ in detail to address new problems or concerns.

Each version is given a distinguishing version number. If the Library specifies a version number of this License which applies to it and "any later version", you have the option of following the terms and conditions either of that version or of any later version published by the Free Software Foundation. If the Library does not specify a license version number, you may choose any version ever published by the Free Software Foundation.

**14.** If you wish to incorporate parts of the Library into other free programs whose distribution conditions are incompatible with these, write to the author to ask for permission. For software which is copyrighted by the Free Software Foundation, write to the Free Software Foundation; we sometimes make exceptions for this. Our decision will be guided by the two goals of preserving the free status of all derivatives of our free software and of promoting the sharing and reuse of software generally.

#### **NO WARRANTY**

**15.** BECAUSE THE LIBRARY IS LICENSED FREE OF CHARGE, THERE IS NO WARRANTY FOR THE LIBRARY, TO THE EXTENT PERMITTED BY APPLICABLE LAW. EXCEPT WHEN OTHERWISE STATED IN WRITING THE COPYRIGHT HOLDERS AND/OR OTHER PARTIES PROVIDE THE LIBRARY "AS IS" WITHOUT WARRANTY OF ANY KIND, EITHER EXPRESSED OR IMPLIED, INCLUDING, BUT NOT LIMITED TO, THE IMPLIED WARRANTIES OF MERCHANTABILITY AND FITNESS FOR A PARTICULAR PURPOSE. THE ENTIRE RISK AS TO THE QUALITY AND PERFORMANCE OF THE LIBRARY IS WITH YOU. SHOULD THE LIBRARY PROVE DEFECTIVE, YOU ASSUME THE COST OF ALL NECESSARY SERVICING, REPAIR OR CORRECTION.

**16.** IN NO EVENT UNLESS REQUIRED BY APPLICABLE LAW OR AGREED TO IN WRITING WILL ANY COPYRIGHT HOLDER, OR ANY OTHER PARTY WHO MAY MODIFY AND/OR REDISTRIBUTE THE LIBRARY AS PERMITTED ABOVE, BE LIABLE TO YOU FOR DAMAGES, INCLUDING ANY GENERAL, SPECIAL, INCIDENTAL OR CONSEQUENTIAL DAMAGES ARISING OUT OF THE USE OR INABILITY TO USE THE LIBRARY (INCLUDING BUT NOT LIMITED TO LOSS OF DATA OR DATA BEING RENDERED INACCURATE OR LOSSES SUSTAINED BY YOU OR THIRD PARTIES OR A FAILURE OF THE LIBRARY TO OPERATE WITH ANY OTHER SOFTWARE), EVEN IF SUCH HOLDER OR OTHER PARTY HAS BEEN ADVISED OF THE POSSIBILITY OF SUCH DAMAGES.

#### **END OF TERMS AND CONDITIONS**

##### **How to Apply These Terms to Your New Libraries**

If you develop a new library, and you want it to be of the greatest possible use to the public, we recommend making it free software that everyone can redistribute and change. You can do so by permitting redistribution under these terms (or, alternatively, under the terms of the ordinary General Public License).

## Install & User's Guide

---

To apply these terms, attach the following notices to the library. It is safest to attach them to the start of each source file to most effectively convey the exclusion of warranty; and each file should have at least the "copyright" line and a pointer to where the full notice is found.

*one line to give the library's name and an idea of what it does.*

Copyright (C) *year* *name of author*

This library is free software; you can redistribute it and/or modify it under the terms of the GNU Lesser General Public License as published by the Free Software Foundation; either version 2.1 of the License, or (at your option) any later version.

This library is distributed in the hope that it will be useful, but WITHOUT ANY WARRANTY; without even the implied warranty of MERCHANTABILITY or FITNESS FOR A PARTICULAR PURPOSE. See the GNU Lesser General Public License for more details.

You should have received a copy of the GNU Lesser General Public License along with this library; if not, write to the Free Software Foundation, Inc., 51 Franklin Street, Fifth Floor, Boston, MA 02110-1301 USA

Also add information on how to contact you by electronic and paper mail.

You should also get your employer (if you work as a programmer) or your school, if any, to sign a "copyright disclaimer" for the library, if necessary. Here is a sample; alter the names:

Yoyodyne, Inc., hereby disclaims all copyright interest in the library `Frob' (a library for tweaking knobs) written by James Random Hacker.

*signature of Ty Coon*, 1 April 1990

Ty Coon, President of Vice

That's all there is to it!

## 7.5.22 Apache License

7.5.23 Version 2.0, January 2004

7.5.24 <http://www.apache.org/licenses/>

## TERMS AND CONDITIONS FOR USE, REPRODUCTION, AND DISTRIBUTION

### 1. Definitions.

"License" shall mean the terms and conditions for use, reproduction, and distribution as defined by Sections 1 through 9 of this document.

"Licensor" shall mean the copyright owner or entity authorized by the copyright owner that is granting the License.

"Legal Entity" shall mean the union of the acting entity and all other entities that control, are controlled by, or are under common control with that entity. For the purposes of this definition, "control" means (i) the power, direct or indirect, to cause the direction or management of such entity, whether by contract or otherwise, or (ii) ownership of fifty percent (50%) or more of the outstanding shares, or (iii) beneficial ownership of such entity.

"You" (or "Your") shall mean an individual or Legal Entity exercising permissions granted by this License.

"Source" form shall mean the preferred form for making modifications, including but not limited to software source code, documentation source, and configuration files.

"Object" form shall mean any form resulting from mechanical transformation or translation of a Source form, including but not limited to compiled object code, generated documentation, and conversions to other media types.

"Work" shall mean the work of authorship, whether in Source or Object form, made available under the License, as indicated by a copyright notice that is included in or attached to the work (an example is provided in the Appendix below).

"Derivative Works" shall mean any work, whether in Source or Object form, that is based on (or derived from) the Work and for which the editorial revisions, annotations, elaborations, or other



modifications represent, as a whole, an original work of authorship. For the purposes of this License, Derivative Works shall not include works that remain separable from, or merely link (or bind by name) to the interfaces of, the Work and Derivative Works thereof.

"Contribution" shall mean any work of authorship, including the original version of the Work and any modifications or additions to that Work or Derivative Works thereof, that is intentionally submitted to Licensor for inclusion in the Work by the copyright owner or by an individual or Legal Entity authorized to submit on behalf of the copyright owner. For the purposes of this definition, "submitted" means any form of electronic, verbal, or written communication sent to the Licensor or its representatives, including but not limited to communication on electronic mailing lists, source code control systems, and issue tracking systems that are managed by, or on behalf of, the Licensor for the purpose of discussing and improving the Work, but excluding communication that is conspicuously marked or otherwise designated in writing by the copyright owner as "Not a Contribution."

"Contributor" shall mean Licensor and any individual or Legal Entity on behalf of whom a Contribution has been received by Licensor and subsequently incorporated within the Work.

**2. Grant of Copyright License.** Subject to the terms and conditions of this License, each Contributor hereby grants to You a perpetual, worldwide, non-exclusive, no-charge, royalty-free, irrevocable copyright license to reproduce, prepare Derivative Works of, publicly display, publicly perform, sublicense, and distribute the Work and such Derivative Works in Source or Object form.

**3. Grant of Patent License.** Subject to the terms and conditions of this License, each Contributor hereby grants to You a perpetual, worldwide, non-exclusive, no-charge, royalty-free, irrevocable (except as stated in this section) patent license to make, have made, use, offer to sell, sell, import, and otherwise transfer the Work, where such license applies only to those patent claims licensable by such Contributor that are necessarily infringed by their Contribution(s) alone or by combination of their Contribution(s) with the Work to which such Contribution(s) was submitted. If You institute patent litigation against any entity (including a cross-claim or counterclaim in a lawsuit) alleging that the Work or a Contribution incorporated within the Work constitutes direct or contributory patent infringement, then any patent licenses granted to You under this License for that Work shall terminate as of the date such litigation is filed.

**4. Redistribution.** You may reproduce and distribute copies of the Work or Derivative Works thereof in any medium, with or without modifications, and in Source or Object form, provided that You meet the following conditions:

1. You must give any other recipients of the Work or Derivative Works a copy of this License; and
2. You must cause any modified files to carry prominent notices stating that You changed the files; and
3. You must retain, in the Source form of any Derivative Works that You distribute, all copyright, patent, trademark, and attribution notices from the Source form of the Work, excluding those notices that do not pertain to any part of the Derivative Works; and
4. If the Work includes a "NOTICE" text file as part of its distribution, then any Derivative Works that You distribute must include a readable copy of the attribution notices contained within such NOTICE file, excluding those notices that do not pertain to any part of the Derivative Works, in at least one of the following places: within a NOTICE text file distributed as part of the Derivative Works; within the Source form or documentation, if provided along with the Derivative Works; or, within a display generated by the Derivative Works, if and wherever such third-party notices normally appear. The contents of the NOTICE file are for informational purposes only and do not modify the License. You may add Your own attribution notices within Derivative Works that You distribute, alongside or as an addendum to the NOTICE text from the Work, provided that such additional attribution notices cannot be construed as modifying the License. You may add Your own copyright statement to Your modifications and may provide additional or different license terms and conditions for use, reproduction, or distribution of Your modifications, or for any such Derivative Works as a whole, provided Your use, reproduction, and distribution of the Work otherwise complies with the conditions stated in this License.

**5. Submission of Contributions.** Unless You explicitly state otherwise, any Contribution intentionally submitted for inclusion in the Work by You to the Licensor shall be under the terms and conditions of this License, without any additional terms or conditions. Notwithstanding the above, nothing herein shall supersede or modify the terms of any separate license agreement you may have executed with Licensor regarding such Contributions.

**6. Trademarks.** This License does not grant permission to use the trade names, trademarks, service marks, or product names of the Licensor, except as required for reasonable and customary use in describing the origin of the Work and reproducing the content of the NOTICE file.

**7. Disclaimer of Warranty.** Unless required by applicable law or agreed to in writing, Licensor provides the Work (and each Contributor provides its Contributions) on an "AS IS" BASIS, WITHOUT WARRANTIES OR CONDITIONS OF ANY KIND, either express or implied, including, without limitation, any warranties or conditions of TITLE, NON-INFRINGEMENT, MERCHANTABILITY, or FITNESS FOR A PARTICULAR PURPOSE. You are solely responsible for determining the appropriateness of using or

redistributing the Work and assume any risks associated with Your exercise of permissions under this License.

**8. Limitation of Liability.** In no event and under no legal theory, whether in tort (including negligence), contract, or otherwise, unless required by applicable law (such as deliberate and grossly negligent acts) or agreed to in writing, shall any Contributor be liable to You for damages, including any direct, indirect, special, incidental, or consequential damages of any character arising as a result of this License or out of the use or inability to use the Work (including but not limited to damages for loss of goodwill, work stoppage, computer failure or malfunction, or any and all other commercial damages or losses), even if such Contributor has been advised of the possibility of such damages.

**9. Accepting Warranty or Additional Liability.** While redistributing the Work or Derivative Works thereof, You may choose to offer, and charge a fee for, acceptance of support, warranty, indemnity, or other liability obligations and/or rights consistent with this License. However, in accepting such obligations, You may act only on Your own behalf and on Your sole responsibility, not on behalf of any other Contributor, and only if You agree to indemnify, defend, and hold each Contributor harmless for any liability incurred by, or claims asserted against, such Contributor by reason of your accepting any such warranty or additional liability.

## END OF TERMS AND CONDITIONS

### 7.5.25 APPENDIX: How to apply the Apache License to your work

To apply the Apache License to your work, attach the following boilerplate notice, with the fields enclosed by brackets "[]" replaced with your own identifying information. (Don't include the brackets!) The text should be enclosed in the appropriate comment syntax for the file format. We also recommend that a file or class name and description of purpose be included on the same "printed page" as the copyright notice for easier identification within third-party archives.

```
Copyright [yyyy] [name of copyright owner]
```

```
Licensed under the Apache License, Version 2.0 (the "License");  
you may not use this file except in compliance with the License.  
You may obtain a copy of the License at
```

```
http://www.apache.org/licenses/LICENSE-2.0
```

Unless required by applicable law or agreed to in writing, software distributed under the License is distributed on an "AS IS" BASIS, WITHOUT WARRANTIES OR CONDITIONS OF ANY KIND, either express or implied. See the License for the specific language governing permissions and limitations under the License.

### **ash license:**

**Copyright (c) 1989, 1991, 1993, 1994 The Regents of the University of California.  
All rights reserved.**

This code is derived from software contributed to Berkeley by Kenneth Almquist

Redistribution and use in source and binary forms, with or without modification, are permitted provided that the following conditions are met:

1. Redistributions of source code must retain the above copyright notice, this list of conditions and the following disclaimer.
2. Redistributions in binary form must reproduce the above copyright notice, this list of conditions and the following disclaimer in the documentation and/or other materials provided with the distribution.
3. Neither the name of the University nor the names of its contributors may be used to endorse or promote products derived from this software without specific prior written permission.

THIS SOFTWARE IS PROVIDED BY THE REGENTS AND CONTRIBUTORS "AS IS" AND ANY EXPRESS OR IMPLIED WARRANTIES, INCLUDING, BUT NOT LIMITED TO, THE IMPLIED WARRANTIES OF MERCHANTABILITY AND FITNESS FOR A PARTICULAR PURPOSE ARE DISCLAIMED. IN NO EVENT SHALL THE REGENTS OR CONTRIBUTORS BE LIABLE FOR ANY DIRECT, INDIRECT, INCIDENTAL, SPECIAL, EXEMPLARY, OR CONSEQUENTIAL DAMAGES (INCLUDING, BUT NOT LIMITED TO, PROCUREMENT OF SUBSTITUTE GOODS OR SERVICES; LOSS OF USE, DATA, OR PROFITS; OR BUSINESS INTERRUPTION) HOWEVER CAUSED AND ON ANY THEORY OF LIABILITY, WHETHER IN CONTRACT, STRICT LIABILITY, OR TORT (INCLUDING NEGLIGENCE OR OTHERWISE) ARISING IN ANY WAY OUT OF THE USE OF THIS SOFTWARE, EVEN IF ADVISED OF THE POSSIBILITY OF SUCH DAMAGE.

**miniupnpc license:**

**Copyright (c) 2005-2009, Thomas BERNARD**

**All rights reserved.**

Redistribution and use of this software in source and binary forms, with or without modification, are permitted provided that the following conditions are met:

- Redistributions of source code must retain the above copyright notice, this list of conditions and the following disclaimer.
- Redistributions in binary form must reproduce the above copyright notice, this list of conditions and the following disclaimer in the documentation and/or other materials provided with the distribution.
- Neither the name of the author may be used to endorse or promote products derived from this software without specific prior written permission.

THIS SOFTWARE IS PROVIDED BY THE COPYRIGHT HOLDERS AND CONTRIBUTORS "AS IS" AND ANY EXPRESS OR IMPLIED WARRANTIES, INCLUDING, BUT NOT LIMITED TO, THE IMPLIED WARRANTIES OF MERCHANTABILITY AND FITNESS FOR A PARTICULAR PURPOSE ARE DISCLAIMED. IN NO EVENT SHALL THE COPYRIGHT OWNER OR CONTRIBUTORS BE LIABLE FOR ANY DIRECT, INDIRECT, INCIDENTAL, SPECIAL, EXEMPLARY, OR CONSEQUENTIAL DAMAGES (INCLUDING, BUT NOT LIMITED TO, PROCUREMENT OF SUBSTITUTE GOODS OR SERVICES; LOSS OF USE, DATA, OR PROFITS; OR BUSINESS INTERRUPTION) HOWEVER CAUSED AND ON ANY THEORY OF LIABILITY, WHETHER IN CONTRACT, STRICT LIABILITY, OR TORT (INCLUDING NEGLIGENCE OR OTHERWISE) ARISING IN ANY WAY OUT OF THE USE OF THIS SOFTWARE, EVEN IF ADVISED OF THE POSSIBILITY OF SUCH DAMAGE.

**telnet-server license:**

**Copyright (c) 1989 Regents of the University of California.**

**All rights reserved.**

Redistribution and use in source and binary forms, with or without modification, are permitted provided that the following conditions are met:

1. Redistributions of source code must retain the above copyright notice, this list of conditions and the following disclaimer.
2. Redistributions in binary form must reproduce the above copyright notice, this list of conditions and the following disclaimer in the documentation and/or other materials provided with the distribution.
3. All advertising materials mentioning features or use of this software must display the following acknowledgement:  
This product includes software developed by the University of California, Berkeley and its contributors.
4. Neither the name of the University nor the names of its contributors may be used to endorse or promote products derived from this software without specific prior written permission.

THIS SOFTWARE IS PROVIDED BY THE REGENTS AND CONTRIBUTORS "AS IS" AND ANY EXPRESS OR IMPLIED WARRANTIES, INCLUDING, BUT NOT LIMITED TO, THE IMPLIED WARRANTIES OF MERCHANTABILITY AND FITNESS FOR A PARTICULAR PURPOSE ARE DISCLAIMED. IN NO EVENT SHALL THE REGENTS OR CONTRIBUTORS BE LIABLE FOR ANY DIRECT, INDIRECT, INCIDENTAL, SPECIAL, EXEMPLARY, OR CONSEQUENTIAL DAMAGES (INCLUDING, BUT NOT LIMITED TO, PROCUREMENT OF SUBSTITUTE GOODS OR SERVICES; LOSS OF USE, DATA, OR PROFITS; OR BUSINESS INTERRUPTION) HOWEVER CAUSED AND ON ANY THEORY OF LIABILITY, WHETHER IN CONTRACT, STRICT LIABILITY, OR TORT (INCLUDING NEGLIGENCE OR OTHERWISE) ARISING IN ANY WAY OUT OF THE USE OF THIS SOFTWARE, EVEN IF ADVISED OF THE POSSIBILITY OF SUCH DAMAGE.

### **YUI License:**

**Copyright (c) 2011, Yahoo! Inc.**

**All rights reserved.**

Redistribution and use of this software in source and binary forms, with or without modification, are permitted provided that the following conditions are met:

- Redistributions of source code must retain the above copyright notice, this list of conditions and the following disclaimer.
- Redistributions in binary form must reproduce the above copyright notice, this list of conditions and the following disclaimer in the documentation and/or other materials provided with the distribution.

- Neither the name of Yahoo! Inc. nor the names of its contributors may be used to endorse or promote products derived from this software without specific prior written permission of Yahoo! Inc.

THIS SOFTWARE IS PROVIDED BY THE COPYRIGHT HOLDERS AND CONTRIBUTORS "AS IS" AND ANY EXPRESS OR IMPLIED WARRANTIES, INCLUDING, BUT NOT LIMITED TO, THE IMPLIED WARRANTIES OF MERCHANTABILITY AND FITNESS FOR A PARTICULAR PURPOSE ARE DISCLAIMED. IN NO EVENT SHALL THE COPYRIGHT OWNER OR CONTRIBUTORS BE LIABLE FOR ANY DIRECT, INDIRECT, INCIDENTAL, SPECIAL, EXEMPLARY, OR CONSEQUENTIAL DAMAGES (INCLUDING, BUT NOT LIMITED TO, PROCUREMENT OF SUBSTITUTE GOODS OR SERVICES; LOSS OF USE, DATA, OR PROFITS; OR BUSINESS INTERRUPTION) HOWEVER CAUSED AND ON ANY THEORY OF LIABILITY, WHETHER IN CONTRACT, STRICT LIABILITY, OR TORT (INCLUDING NEGLIGENCE OR OTHERWISE) ARISING IN ANY WAY OUT OF THE USE OF THIS SOFTWARE, EVEN IF ADVISED OF THE POSSIBILITY OF SUCH DAMAGE.

### **ppp license:**

**Copyright (c) 1993 The Australian National University.**

**All rights reserved.**

Redistribution and use in source and binary forms are permitted provided that the above copyright notice and this paragraph are duplicated in all such forms and that any documentation, advertising materials, and other materials related to such distribution and use acknowledge that the software was developed by the Australian National University. The name of the University may not be used to endorse or promote products derived from this software without specific prior written permission. THIS SOFTWARE IS PROVIDED "AS IS" AND WITHOUT ANY EXPRESS OR IMPLIED WARRANTIES, INCLUDING, WITHOUT LIMITATION, THE IMPLIED WARRANTIES OF MERCHANTABILITY AND FITNESS FOR A PARTICULAR PURPOSE.

**Copyright (c) 1989 Carnegie Mellon University.**

**All rights reserved.**

Redistribution and use in source and binary forms are permitted provided that the above copyright notice and this paragraph are duplicated in all such forms and that any documentation, advertising materials, and other materials related to such distribution and use acknowledge that the software was developed by Carnegie Mellon University. The name of the University may not be used to endorse or promote products derived from this software without specific prior written permission.

THIS SOFTWARE IS PROVIDED "AS IS" AND WITHOUT ANY EXPRESS OR IMPLIED WARRANTIES, INCLUDING, WITHOUT LIMITATION, THE IMPLIED WARRANTIES OF MERCHANTABILITY AND FITNESS FOR A PARTICULAR PURPOSE.

**c-res license:**

**Copyright 1998 by the Massachusetts Institute of Technology.**

Permission to use, copy, modify, and distribute this software and its documentation for any purpose and without fee is hereby granted, provided that the above copyright notice appear in all copies and that both that copyright notice and this permission notice appear in supporting documentation, and that the name of M.I.T. not be used in advertising or publicity pertaining to distribution of the software without specific, written prior permission.

M.I.T. makes no representations about the suitability of this software for any purpose. It is provided "as is" without express or implied warranty.

**curl license:**

**Copyright (c) 1996 - 2010, Daniel Stenberg, <daniel@haxx.se>.**

**All rights reserved.**

Permission to use, copy, modify, and distribute this software for any purpose with or without fee is hereby granted, provided that the above copyright notice and this permission notice appear in all copies.

THE SOFTWARE IS PROVIDED "AS IS", WITHOUT WARRANTY OF ANY KIND, EXPRESS OR IMPLIED, INCLUDING BUT NOT LIMITED TO THE WARRANTIES OF MERCHANTABILITY, FITNESS FOR A PARTICULAR PURPOSE AND NONINFRINGEMENT OF THIRD PARTY RIGHTS. IN NO EVENT SHALL THE AUTHORS OR COPYRIGHT HOLDERS BE LIABLE FOR ANY CLAIM, DAMAGES OR OTHER LIABILITY, WHETHER IN AN ACTION OF CONTRACT, TORT OR OTHERWISE, ARISING FROM, OUT OF OR IN CONNECTION WITH THE SOFTWARE OR THE USE OR OTHER DEALINGS IN THE SOFTWARE.



Except as contained in this notice, the name of a copyright holder shall not be used in advertising or otherwise to promote the sale, use or other dealings in this Software without prior written authorization of the copyright holder.

### **liboauth license:**

**Copyright 2007, 2008 Robin Gareus <[robin@gareus.org](mailto:robin@gareus.org)>**

Unless otherwise indicated, Source Code is licensed under MIT license.

Permission is hereby granted, free of charge, to any person obtaining a copy of this software and associated documentation files (the "Software"), to deal in the Software without restriction, including without limitation the rights to use, copy, modify, merge, publish, distribute, sublicense, and/or sell copies of the Software, and to permit persons to whom the Software is furnished to do so, subject to the following conditions:

The above copyright notice and this permission notice shall be included in all copies or substantial portions of the Software.

THE SOFTWARE IS PROVIDED "AS IS", WITHOUT WARRANTY OF ANY KIND, EXPRESS OR IMPLIED, INCLUDING BUT NOT LIMITED TO THE WARRANTIES OF MERCHANTABILITY, FITNESS FOR A PARTICULAR PURPOSE AND NONINFRINGEMENT. IN NO EVENT SHALL THE AUTHORS OR COPYRIGHT HOLDERS BE LIABLE FOR ANY CLAIM, DAMAGES OR OTHER LIABILITY, WHETHER IN AN ACTION OF CONTRACT, TORT OR OTHERWISE, ARISING FROM, OUT OF OR IN CONNECTION WITH THE SOFTWARE OR THE USE OR OTHER DEALINGS IN THE SOFTWARE.

### **jcodec license:**

**Copyright (c) 2011 The jcodec project. <<http://code.google.com/p/jcodec/>>**

Permission is hereby granted, free of charge, to any person obtaining a copy of this software and associated documentation files (the "Software"), to deal in the Software without restriction, including without limitation the rights to use, copy, modify, merge, publish, distribute, sublicense, and/or sell copies of the Software, and to permit persons to whom the Software is furnished to do so, subject to the following conditions:

The above copyright notice and this permission notice shall be included in all copies or substantial portions of the Software.

THE SOFTWARE IS PROVIDED "AS IS", WITHOUT WARRANTY OF ANY KIND, EXPRESS OR IMPLIED, INCLUDING BUT NOT LIMITED TO THE WARRANTIES OF MERCHANTABILITY, FITNESS FOR A PARTICULAR PURPOSE AND NONINFRINGEMENT. IN NO EVENT SHALL THE AUTHORS OR COPYRIGHT HOLDERS BE LIABLE FOR ANY CLAIM, DAMAGES OR OTHER LIABILITY, WHETHER IN AN ACTION OF CONTRACT, TORT OR OTHERWISE, ARISING FROM, OUT OF OR IN CONNECTION WITH THE SOFTWARE OR THE USE OR OTHER DEALINGS IN THE SOFTWARE.

### **OpenSSL License:**

#### **Copyright (c) 1998-2011 The OpenSSL Project. All rights reserved.**

Redistribution and use in source and binary forms, with or without modification, are permitted provided that the following conditions are met:

1. Redistributions of source code must retain the above copyright notice, this list of conditions and the following disclaimer.
2. Redistributions in binary form must reproduce the above copyright notice, this list of conditions and the following disclaimer in the documentation and/or other materials provided with the distribution.
3. All advertising materials mentioning features or use of this software must display the following acknowledgment:  
"This product includes software developed by the OpenSSL Project for use in the OpenSSL Toolkit. (<http://www.openssl.org/>)"
4. The names "OpenSSL Toolkit" and "OpenSSL Project" must not be used to endorse or promote products derived from this software without prior written permission. For written permission, please contact [openssl-core@openssl.org](mailto:openssl-core@openssl.org).
5. Products derived from this software may not be called "OpenSSL" nor may "OpenSSL" appear in their names without prior written permission of the OpenSSL Project.
6. Redistributions of any form whatsoever must retain the following acknowledgment:  
"This product includes software developed by the OpenSSL Project for use in the OpenSSL Toolkit (<http://www.openssl.org/>)"

THIS SOFTWARE IS PROVIDED BY THE OPENSSL PROJECT "AS IS" AND ANY EXPRESSED OR IMPLIED WARRANTIES, INCLUDING, BUT NOT LIMITED TO, THE IMPLIED WARRANTIES OF MERCHANTABILITY

AND FITNESS FOR A PARTICULAR PURPOSE ARE DISCLAIMED. IN NO EVENT SHALL THE OpenSSL PROJECT OR ITS CONTRIBUTORS BE LIABLE FOR ANY DIRECT, INDIRECT, INCIDENTAL, SPECIAL, EXEMPLARY, OR CONSEQUENTIAL DAMAGES (INCLUDING, BUT NOT LIMITED TO, PROCUREMENT OF SUBSTITUTE GOODS OR SERVICES; LOSS OF USE, DATA, OR PROFITS; OR BUSINESS INTERRUPTION) HOWEVER CAUSED AND ON ANY THEORY OF LIABILITY, WHETHER IN CONTRACT, STRICT LIABILITY, OR TORT (INCLUDING NEGLIGENCE OR OTHERWISE) ARISING IN ANY WAY OUT OF THE USE OF THIS SOFTWARE, EVEN IF ADVISED OF THE POSSIBILITY OF SUCH DAMAGE.

This product includes cryptographic software written by Eric Young(eay@cryptsoft.com). This product includes software written by Tim Hudson (tjh@cryptsoft.com).

### Original SSLeay License

---

**Copyright (C) 1995-1998 Eric Young (eay@cryptsoft.com)**

**All rights reserved.**

This package is an SSL implementation written by Eric Young (eay@cryptsoft.com).

The implementation was written so as to conform with Netscapes SSL.

This library is free for commercial and non-commercial use as long as the following conditions are aheared to. The following conditions apply to all code found in this distribution, be it the RC4, RSA, lhash, DES, etc., code; not just the SSL code. The SSL documentation included with this distribution is covered by the same copyright terms except that the holder is Tim Hudson (tjh@cryptsoft.com).

Copyright remains Eric Young's, and as such any Copyright notices in the code are not to be removed. If this package is used in a product, Eric Young should be given attribution as the author of the parts of the library used. This can be in the form of a textual message at program startup or in documentation (online or textual) provided with the package.

Redistribution and use in source and binary forms, with or without modification, are permitted provided that the following conditions are met:

1. Redistributions of source code must retain the copyright notice, this list of conditions and the following disclaimer.
2. Redistributions in binary form must reproduce the above copyright notice, this list of conditions and the following disclaimer in the documentation and/or other materials provided with the distribution.
3. All advertising materials mentioning features or use of this software must display the following acknowledgement:

"This product includes cryptographic software written by Eric Young (eay@cryptsoft.com)"

The word 'cryptographic' can be left out if the routines from the library being used are not cryptographic related :-).

4. If you include any Windows specific code (or a derivative thereof) from the apps directory (application code) you must include an acknowledgement:

"This product includes software written by Tim Hudson (tjh@cryptsoft.com)"

THIS SOFTWARE IS PROVIDED BY ERIC YOUNG "AS IS" AND ANY EXPRESS OR IMPLIED WARRANTIES, INCLUDING, BUT NOT LIMITED TO, THE IMPLIED WARRANTIES OF MERCHANTABILITY AND FITNESS FOR A PARTICULAR PURPOSE ARE DISCLAIMED. IN NO EVENT SHALL THE AUTHOR OR CONTRIBUTORS BE LIABLE FOR ANY DIRECT, INDIRECT, INCIDENTAL, SPECIAL, EXEMPLARY, OR CONSEQUENTIAL DAMAGES (INCLUDING, BUT NOT LIMITED TO, PROCUREMENT OF SUBSTITUTE GOODS OR SERVICES; LOSS OF USE, DATA, OR PROFITS; OR BUSINESS INTERRUPTION) HOWEVER CAUSED AND ON ANY THEORY OF LIABILITY, WHETHER IN CONTRACT, STRICT LIABILITY, OR TORT (INCLUDING NEGLIGENCE OR OTHERWISE) ARISING IN ANY WAY OUT OF THE USE OF THIS SOFTWARE, EVEN IF ADVISED OF THE POSSIBILITY OF SUCH DAMAGE.

The licence and distribution terms for any publically available version or derivative of this code cannot be changed. i.e. this code cannot simply be copied and put under another distribution licence [including the GNU Public Licence.]

## **SIL OPEN FONT LICENSE**

Version 1.1 - 26 February 2007

### **7.5.26 PREAMBLE**

The goals of the Open Font License (OFL) are to stimulate worldwide development of collaborative font projects, to support the font creation efforts of academic and linguistic communities, and to provide a free and open framework in which fonts may be shared and improved in partnership with others.

The OFL allows the licensed fonts to be used, studied, modified and redistributed freely as long as they are not sold by themselves. The fonts, including any derivative works, can be bundled, embedded, redistributed and/or sold with any software provided that any reserved names are not

used by derivative works. The fonts and derivatives, however, cannot be released under any other type of license. The requirement for fonts to remain under this license does not apply to any document created using the fonts or their derivatives.

### **7.5.27 DEFINITIONS**

"Font Software" refers to the set of files released by the Copyright Holder(s) under this license and clearly marked as such. This may include source files, build scripts and documentation.

"Reserved Font Name" refers to any names specified as such after the copyright statement(s).

"Original Version" refers to the collection of Font Software components as distributed by the Copyright Holder(s).

"Modified Version" refers to any derivative made by adding to, deleting, or substituting — in part or in whole — any of the components of the Original Version, by changing formats or by porting the Font Software to a new environment.

"Author" refers to any designer, engineer, programmer, technical writer or other person who contributed to the Font Software.

### **7.5.28 PERMISSION & CONDITIONS**

Permission is hereby granted, free of charge, to any person obtaining a copy of the Font Software, to use, study, copy, merge, embed, modify, redistribute, and sell modified and unmodified copies of the Font Software, subject to the following conditions:

- 1) Neither the Font Software nor any of its individual components, in Original or Modified Versions, may be sold by itself.
- 2) Original or Modified Versions of the Font Software may be bundled, redistributed and/or sold with any software, provided that each copy contains the above copyright notice and this license. These can be included either as stand-alone text files, human-readable headers or in the appropriate machine-readable metadata fields within text or binary files as long as those fields can be easily viewed by the user.

3) No Modified Version of the Font Software may use the Reserved Font Name(s) unless explicit written permission is granted by the corresponding Copyright Holder. This restriction only applies to the primary font name as presented to the users.

4) The name(s) of the Copyright Holder(s) or the Author(s) of the Font Software shall not be used to promote, endorse or advertise any Modified Version, except to acknowledge the contribution(s) of the Copyright Holder(s) and the Author(s) or with their explicit written permission.

5) The Font Software, modified or unmodified, in part or in whole, must be distributed entirely under this license, and must not be distributed under any other license. The requirement for fonts to remain under this license does not apply to any document created using the Font Software.

#### **7.5.29 TERMINATION**

This license becomes null and void if any of the above conditions are not met.

#### **7.5.30 DISCLAIMER**

THE FONT SOFTWARE IS PROVIDED "AS IS", WITHOUT WARRANTY OF ANY KIND, EXPRESS OR IMPLIED, INCLUDING BUT NOT LIMITED TO ANY WARRANTIES OF MERCHANTABILITY, FITNESS FOR A PARTICULAR PURPOSE AND NONINFRINGEMENT OF COPYRIGHT, PATENT, TRADEMARK, OR OTHER RIGHT. IN NO EVENT SHALL THE COPYRIGHT HOLDER BE LIABLE FOR ANY CLAIM, DAMAGES OR OTHER LIABILITY, INCLUDING ANY GENERAL, SPECIAL, INDIRECT, INCIDENTAL, OR CONSEQUENTIAL DAMAGES, WHETHER IN AN ACTION OF CONTRACT, TORT OR OTHERWISE, ARISING FROM, OUT OF THE USE OR INABILITY TO USE THE FONT SOFTWARE OR FROM OTHER DEALINGS IN THE FONT SOFTWARE.

**HUNT ELECTRONIC USA INC.**

11790 Jersey Blvd.

Rancho Cucamonga, CA 91730

Tel: (888)993-4868, (909)987-6999

Fax: (909)987-6997

[techsupport@huntcctv.com](mailto:techsupport@huntcctv.com)

[www.huntcctv.com](http://www.huntcctv.com)