

Control Center Std

User's Guide

(v 1.10)



Contents

1. Product Overview	6
1.1. What is Control Center?	6
1.2. PC System Requirements	6
1.3. Installation Program	7
1.4. Program log in	9
2. Control Center Monitor	10
2.1. Interface.....	10
2.1.1. View area	10
2.1.2. Tool bar.....	12
2.2. Unit mode	13
2.2.1. Making/deleting a sub folder	13
2.2.2. Registering /deleting unit.....	13
2.2.3. Revising information of unit.....	14
2.2.4. Viewing image.....	14
2.3. View set mode	15
2.3.1. Registering / deleting view set.....	15
2.3.2. Viewing image.....	16
2.4. Map mode.....	17
2.4.1. Map Editor.....	17
2.4.2. Registering/deleting map	18
2.4.3. Viewing map.....	19
2.4.4. Controlling device of map	19
2.4.5. Arranging map window	20
2.5. Monitor screen.....	20
2.5.1. Screen interface	20
2.5.2. Screen division	20
2.5.3. Full screen	20
2.5.4. Moving screen	21
2.5.5. Caption information.....	21
2.5.6. Image transmission speed.....	21
2.5.7. Image resolution	21
2.5.8. Stream.....	21

2.5.9.	Event.....	22
2.5.10.	Saving image	22
2.5.11.	PTZ control.....	23
2.5.12.	Audio control.....	24
2.5.13.	Close all.....	24
2.6.	Alarm log.....	24
2.6.1.	Event information	24
2.6.2.	Viewing image.....	25
2.6.3.	Viewing Detailed Message	25
2.7.	Status & Action.....	25
2.7.1.	Status& Action information	25
2.7.2.	Viewing image.....	26
2.7.3.	Alarm notification setting at each unit.....	26
2.8.	Automatic image switching	26
2.9.	Alarm pop up.....	27
2.10.	Event search.....	27
2.11.	Program user configuration	28
2.12.	Option setting	28
2.12.1.	Caption	28
2.12.2.	Monitor.....	29
2.12.3.	Save	30
2.12.4.	Alarm.....	31
2.12.5.	Automatic image switching	33
2.12.6.	Frame Rate.....	33
2.12.7.	Map.....	33
3.	Control Center Playback	34
3.1.	Interface.....	34
3.1.1.	View area	34
3.1.2.	Tool bar.....	35
3.2.	Opening unit/backup file	35
3.3.	Search	36
3.3.1.	Image information indication	36
3.3.2.	Change of search section	36

3.3.3.	Channel selection.....	36
3.3.4.	Calendar search.....	36
3.3.5.	Log information indication & Search	36
3.3.6.	Text search.....	37
3.3.7.	Smart search	37
3.3.8.	Thumbnail search	38
3.4.	Playback	39
3.4.1.	Playback button	39
3.4.2.	Audio playback.....	39
3.4.3.	Text.....	39
3.4.4.	Time zone selection	39
3.5.	Image control.....	40
3.5.1.	Zoom/Brightness/Contrast control.....	40
3.5.2.	Image save	40
3.5.3.	Image print.....	40
3.6.	Backup function.....	41
3.7.	Backup Log function	41
3.8.	DVrS unit search.....	42
3.9.	Option setting	44
3.9.1.	Caption	44
3.9.2.	Adjustment of screen division	44
4.	Configuration Tools.....	45
4.1.	Interface.....	45
4.1.1.	Site Tree.....	45
4.1.2.	Menu.....	46
4.1.3.	Configuration page	46
5.	Schedule Backup.....	47
5.1.	Backup setup	48
5.1.1.	Backup file name	48
5.1.2.	Password.....	49
5.1.3.	Preservation	49
5.1.4.	Destination.....	50
5.1.5.	Auto deletion setting.....	50
5.1.6.	Select backup data range	50

5.1.7.	Backup Timetable	51
5.1.8.	System Tray icon	52
5.1.9.	Backup file.....	53
5.2.	Backup status.....	53
5.2.1.	Detailed information.....	54
5.2.2.	Detailed backup history	55
5.2.3.	Stop backup	55
APPENDIX		56
#1	Control Center Series Introduction and How to Configure System.....	57
#1.1	What is Control Center?	57
#1.2	Comparison Chart for Control Center Series.....	58
#1.3	Key Features and Configuraion of Control Center	58
#1.4	System Diagram using Control Center	61
#2	WinDVrS Introduction and System Configuration	62
#2.1	What is WinDVrS?	62
#2.2	Key Features of WinDVrS	62
#2.3	Key Features of WinDVrS Series	62
#3	SDK Introduction for Powerful Application	64
#3.1	WESP (WEBGATE Embedded System Protocol) SDK.....	64
#3.2	Key Features of SDK.....	64
#3.3	SDK Configuration.....	64
#3.4	SDK Usage Example	64

The contents of this manual can be different in accordance with Software upgrade and design/ specification can be partly modified without prior notice to user.

1. Product Overview

1.1. What is Control Center?

Control Center is managing software that can control max 1000 units installed in remote area.

It provides functions such as real-time monitoring, search and backup of recorded image and setting. It also supports dual monitor and can monitor max 128 channels simultaneously. So effective search can be done : It can be done with designated motion area, and text search is also possible.

It allows user to understand and deal with various situation of each unit. Also it provides function such as recording and searching event. If event is triggered, relevant image can be pop-up.

It is to easily control many units classified according to view set and map.

1.2. PC System Requirements

	Minimum	Recommended
CPU	Intel Pentium 4 / 3.0GHz	Core2duo E6750 or higher
Memory	1GB	2GB or higher
Video Card	128MB	512MB or higher
Resolution	1280 x 1024 (with 32bit color) or higher	
HDD storage space	80GB or higher	
OS	Windows XP Professional / Window Vista Business	
Others	DirectX 9.0 or higher	

Control Center is optimized for XP (service pack2 recommended).

In case using the video driver which is provided from Microsoft, the display in user's screen could be seriously flickering and its efficiency can decrease, so do not use DirectX, or establish the up-to-date driver which is provided from the video card manufacturing company.

1.3. Installation Program

1) Run “1.x.x.x Setup.exe” file in Control Center Setup CD.

In order to install Control Center, user account on local PC should be Administrator.

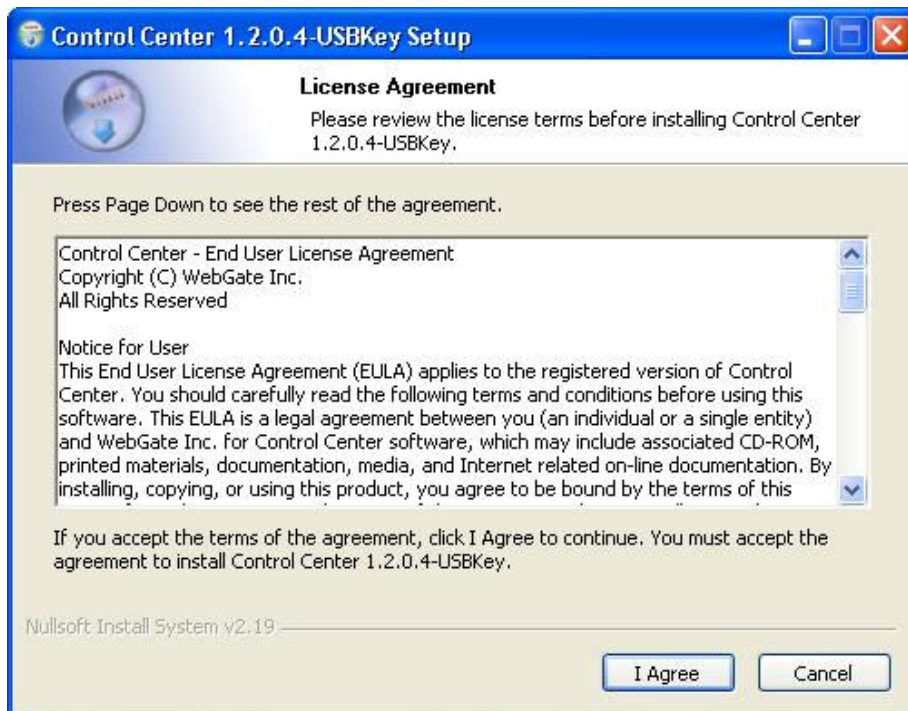

2) Click on “I Agree” button.

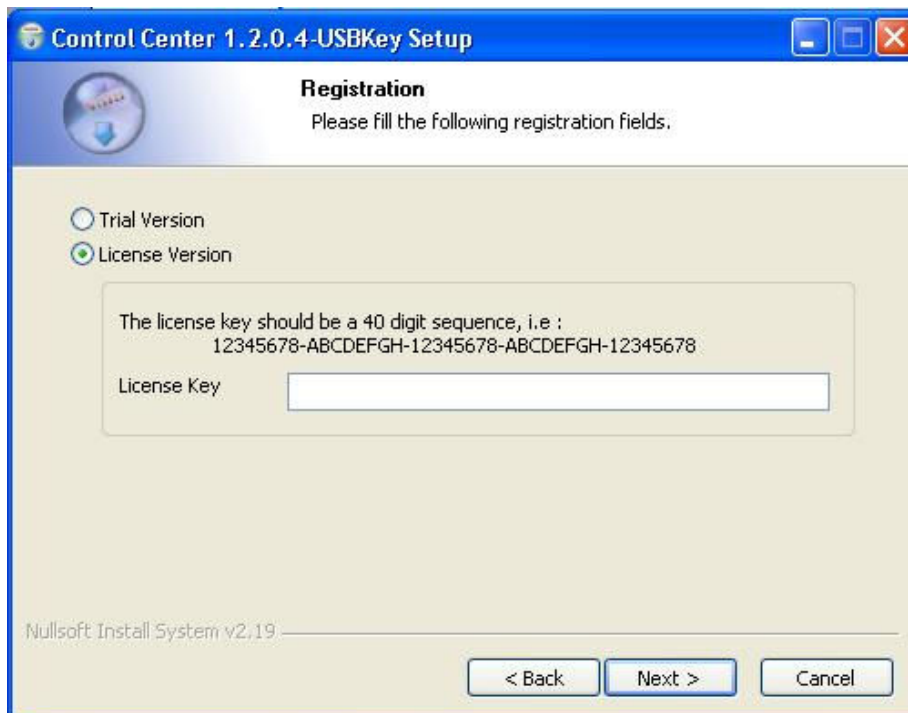

3) When registering with using USB key, it should be put in PC. Unless Key Driver is installed, the program installs USB Key Driver automatically.

After the Driver is installed, the program moves to next page and shows license key from USB Key automatically. If installing without USB Key, enter the supplied license key and press the “Next” button. Trial version can be used for 30 days, if it exceeds that period, you can not run it anymore.

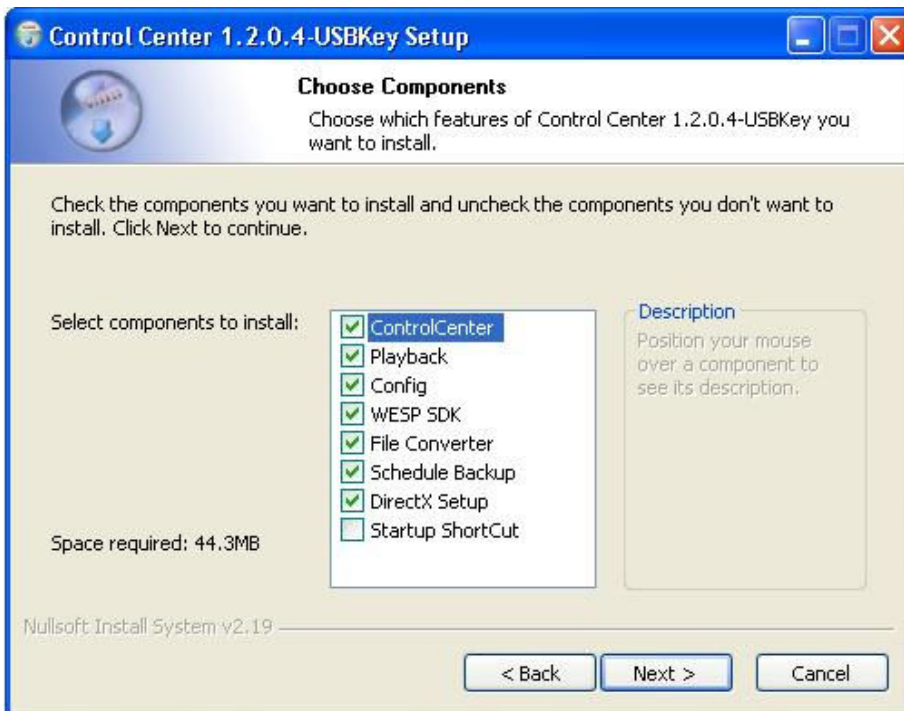

4) Choose components and press “Next” button. WESP SDK should be installed.

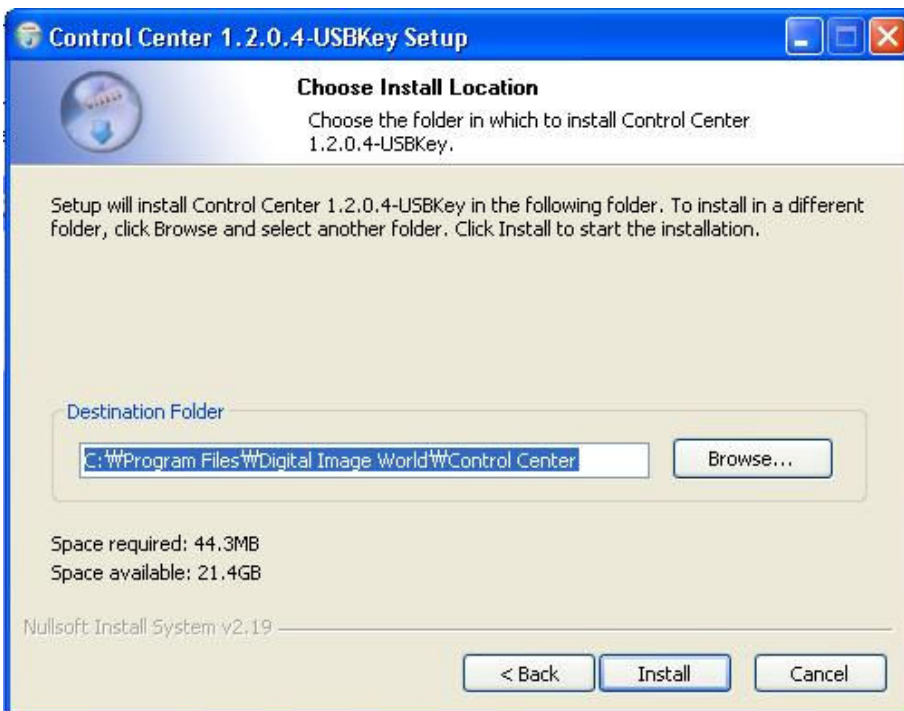

5) Select folder and press “Install” button.

1.4. Program log in

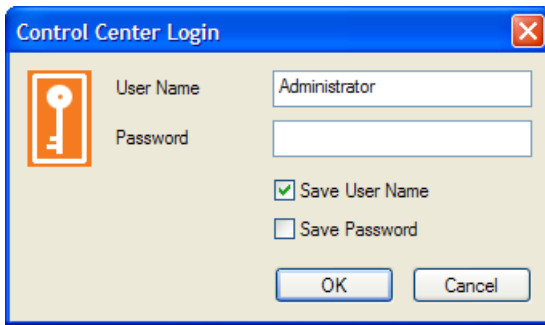

The image shows a Windows-style dialog box titled "Control Center Login". It has a blue title bar with a close button (X) in the top right corner. On the left side, there is an orange icon of a key. To the right of the icon, there are two text input fields: "User Name" containing the text "Administrator" and "Password" which is empty. Below the input fields, there are two checkboxes: "Save User Name" which is checked, and "Save Password" which is unchecked. At the bottom of the dialog, there are two buttons: "OK" and "Cancel".

Click the “OK” button after inputting ID and Password. When login becomes correct, Control Center program will run. The default user is “Administrator” and password is “admin”. The user’s authority to run program is restricted respectively.

2. Control Center Monitor

2.1. Interface



















2.1.1. View area

It has unit explorer in the left part of screen, image or map in the center part of screen, event situation in the lower part of screen. It is composed of total three view areas.

Unit Explorer

It shows unit, view set and map in tree list according to each mode. Register, edit and eliminate unit /view set /map.

(Table. Tree Icon)

Icon	Function
	The folder that manages registered unit.
	Shows the unit which is detected and not registered in “My Units” at local network.
	User can make the lower folder and manage it if user have registered unit.
	Shows the unit which does not have HDD fails in connection.
	Shows the unit which does not have HDD fails in log in.
	Shows the unit which does not have HDD succeeds in log in.
	When alarm signal comes in, it flicks for 5 seconds.
	Shows all video channels of the unit are monitoring.
	Indicates that a unit has HDD.
	Indicates that a unit is DVrS.
	Video Channel
	Sensor
	Relay out
	Audio out (Talk)
	View set
	Map
	Inside folder of map (channel, sensor, relay out and talk)

Main View

It shows monitor screen and map window according to each mode.

Event View

























The event history shows event which occurs from the unit registered in “My Units” at real-time. The Status & Action shows current event situation of each unit and control relay output, audio output device.

Click  button to lead to docking of event view.

2.1.2. Tool bar

There are buttons on top area, so user can make use of functions easily.

(Table. Control Center Tool Bar)

Button	Function
	Hides "Unit Explore"
	Hides "Event View"
	Displays "Main View" with a full screen
	Executes playback program
	Executes configuration program
	Can search stored events according to date, unit and category
	Sets option menus.
	Adds unit, view set and map. **
	Changes information of unit, view set and map. **
	Deletes unit, view set and map. **
	Stores current monitoring status as view set. **
	Renews information of unit tree (connection status, detected unit list, etc).
	Monitors the registered unit and view set by auto switching mode.
	Turns on/off alarm pop up.
5 frames/sec ▾	Change frame rate.
	Closes connection which is in monitoring, or closes all map windows.
	Close a connection during monitoring or windows whether it is open or not.
	Selects the map which will be located on the top part among many maps of map mode
	Arranges maps with cascade.
	Arranges maps with tile style.
 ~ 	Divides monitor screen by 1~64. (1, 4, 9, 13, 16, 25, 36, 49, 64)
Auto ▾	Change resolution of monitor (In case of multi monitor, each menu exist).
	Select the current monitor whether sequence switching is used or not.
	Select the monitor whether alarm popup is used or not.
	Confirms information of control center version.

(**This indication means only the user who has authority of setting control center is allowed to use)

2.2. Unit mode

It registers many units and manages them. User can easily register a unit searched by “Discover” and showed in “Local Area Units” folder. User can understand unit connection status through icon.

2.2.1. Making/deleting a sub folder

If selecting “Add Folder” from pop up menu after clicking on “My Units” folder, the dialogue box where user can input folder name will be indicated. When entering folder name and clicking “OK” button, new folder will be created.

In order to delete folder, select the “Delete Folder” from pop up menu after clicking it. If there are registered units in the folder that user wants to delete, they will be also deleted together.

2.2.2. Registering /deleting unit

If user drags and drops a unit from “Local Area Units” to “My Units” or chooses  “Add Unit” from pop up menu after clicking “My Units”, user will see registration dialogue box. Or, select “Add” menu of tool bar. (Add menu may be disabled according to maximal number of registrable units)

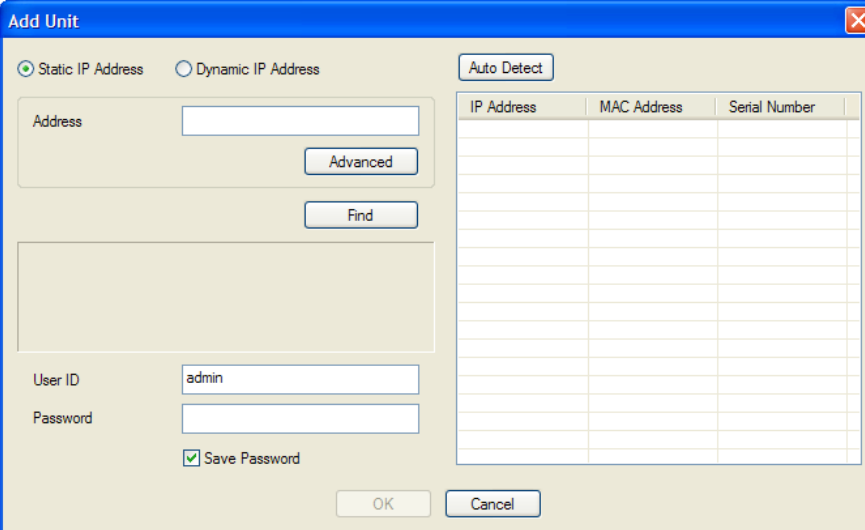

IP Address	MAC Address	Serial Number

Registration of static IP unit

In order to register a unit by using “Add Unit” menu, input IP address and click “Find” button. At this time user can change port number by clicking “Advanced” button if number of unit is not default 80. User can bring server information through process of server finding. And then “OK” button will be activated. Input user ID, password and click “OK” button.

User will see the detected units in the list by clicking on “Auto Detect” button. Select the unit that user wants to register and input user information.

User will find basic information, if user drags and drops it from “Local Area Unit”. So just input user information and click on “OK” button.

Registration of dynamic IP unit

User can manage a unit which has dynamic IP address with registration server. (About WRS registration, please refer to 4.Configuration)

Click the “Find” button after selecting “Dynamic IP Address” radio button and inputting registration server/serial number. When search process is done successfully, user will input user information and register it.

Using group ID, the unit registered at Registration Server can be searched by selecting "Dynamic IP Address" radio button, typing Registration Server, typing Group ID, and pressing "Find by Group ID".

Change of unit information

In order to change information of registered unit, select “Edit Unit” from pop up menu after selecting a unit. Then a dialogue box will appear. Or select  “Edit” menu of tool bar, user can change port number and user information.

Deletion of unit

In order to delete registered unit, select “Delete Unit” from pop up menu. Or select  “Delete” menu of tool bar.

2.2.3. Revising information of unit

If selecting “Refresh” from pop up menu of unit tree or clicking “Refresh” button of tool bar, information of registered unit and detected unit list at network will be renewed.

2.2.4. Viewing image

When unit is connected, the video channel of unit in tree will be shown. User can see live image on monitor of “Main View” after selecting certain channel. If user drags and drops channel item to monitor, an image will be displayed at the designated location. In order to see all channels of certain unit, select an icon of unit, then all channels will be played and screen division will be changed according to number of channel.

2.3. View set mode

When registering group of channels in “View Set”, user can easily manage them. Select “View Set” tab in “Unit Explorer”.

2.3.1. Registering / deleting view set

Quick Save View Set

User can register the current monitoring at site mode as view set. After selecting channel, click  “Quick Save View Set” button of tool bar. Information such as current division, channel, frame rate and resolution will be saved together with it.

Registration on the menu

When selecting “Add View Set” from pop up menu, the registration dialogue box is open. Or click on  “Add” menu of tool bar.

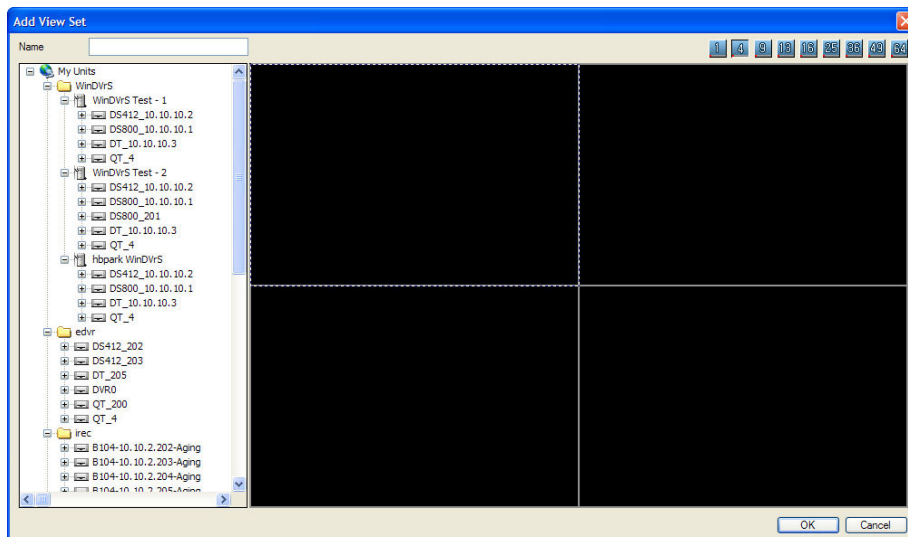

Edit View Set

When selecting “View Set” and then “Edit View Set” from pop up menu, the dialogue box is open. Or click on  “Edit” menu of tool bar.

Delete View Set

When selecting “View Set” and then “Delete View Set” from pop up menu, the dialogue box is open. Or click on  “Delete” menu of tool bar.

2.3.2. Viewing image

When selecting the registered view set or dragging and dropping it, screen is divided according to division of view set and channel of view set is played.

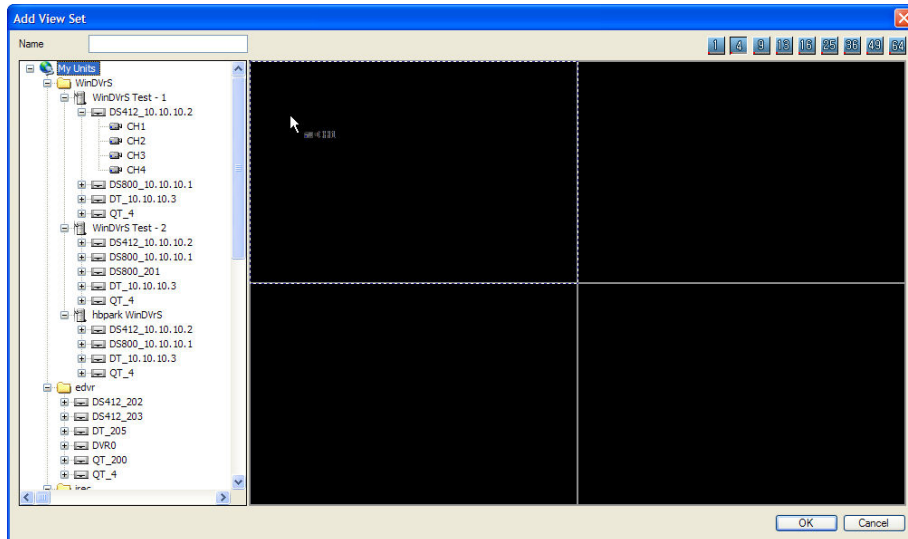

2.4. Map mode



User can manage system relating to channel, audio out, relay out, and sensor by way of registering them in the map. Select the map tab of “Unit Explorer”.

2.4.1. Map Editor

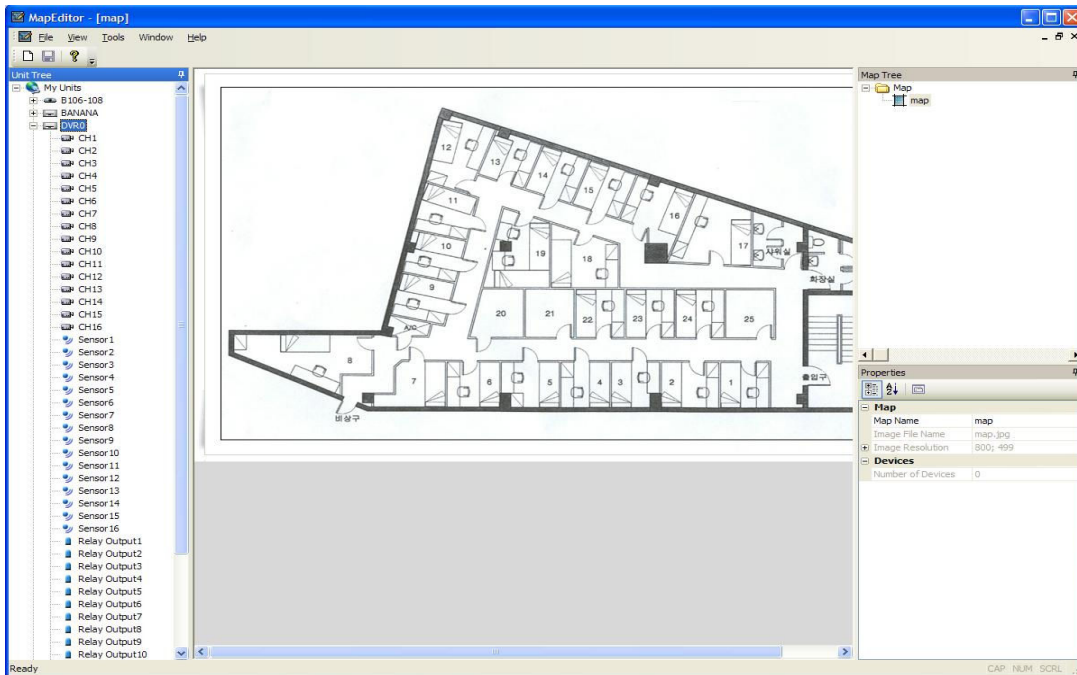
Run “Tools>Map Editor” in map mode.



(Table : Map Editor Tool Bar)

Button	Function
	Add a Map
	Save map information

Unit Tree

Display available map registration unit and device, which is available unit registration at only Monitor program.

Toolbox

In case of putting submap/maplink at a map, add this icon by Drag&Drop.







Map Tree

Display tree type to view easily map configuration with the attached device. If you select item from a map tree, “Properties” window will display edit available item.

Properties

Edit the item contents selected from a Map Tree.

(Table : The Icon Properties at Map Tree)

Icon	Type	Properties
	Folder	None
	Map	Map Name
	Channel	None
	Sensor	None
	Relay	None
	Audio	None

Register User Icon

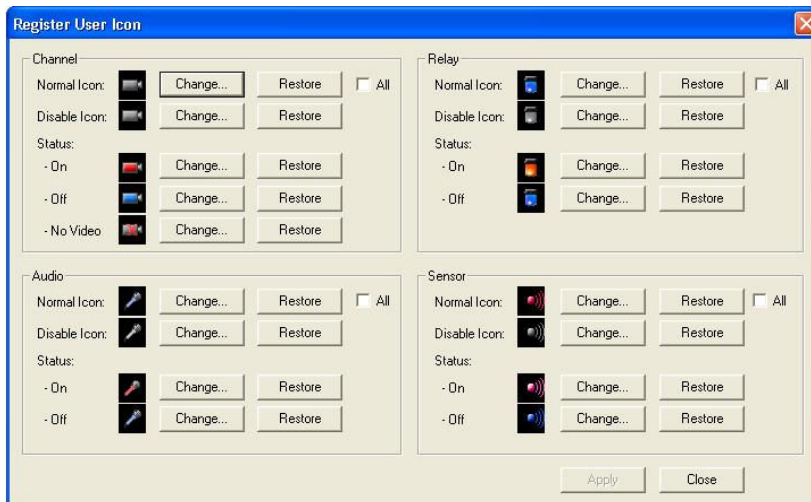

As for icon, user can register the image which he/she wants to display. JPEG, GIF and BMP can be registered.

User can execute this function in 'Tools > Register User Icon' of Map Editor Menu.

2.4.2. Registering/deleting map

Registration of map

Map Editor will be executed if user selects "Add Map" from pop up menu of map tree or just clicks on  "Add" menu of tool bar.

Edition of map

"Map Editor" will be executed if user selects "Edit Map" from pop up menu of map tree or just clicks on  "Edit" menu of tool bar.

Deletion of map

Select “Delete Map” from pop up menu of map tree or click on  “Delete” menu of tool bar.

2.4.3. Viewing map

If user selects the map in map tree, window of map will be opened.

2.4.4. Controlling device of map

Viewing image

If user selects the channel of “Channel(s)” folder of map tree or selects channel icon of map window, live image monitor will be popped up.



Sensor

If sensor that is registered in the map is on, the sensor of the map will start flicking.



Relay out

If relay out that is registered in the map is on, relay icon of the map will start flicking. User can make relay out on/off by clicking on its icon of the map.

Audio out

User can transmit audio to the unit by selecting audio out.

2.4.5. Arranging map window

User can arrange windows in  cascade or  tile when user opens many map windows on screen. Select  if wanting to place specific map window on the top part.





2.5. Monitor screen

2.5.1. Screen interface



On the top part there is caption title. It has button for unit, name of channel, PTZ, and Audio control. To the lower part of screen it shows time and event information.

(Table. Monitor menu button)

Button	Function
	Stores live image (re4 file)
	PTZ
	Audio on/off
	Closes connection of monitor

2.5.2. Screen division



The number of screen division is diverse (1/4/9/13/16/25/36/49/64).

2.5.3. Full screen

When selecting “Full Screen” menu , the window of main view will be converted to the full screen. Press Esc key if wanting conversion to the original mode.

2.5.4. Moving screen

Drag and drop an image while pressing the left button of mouse, if wanting to exchange image of two monitors.

2.5.5. Caption information

Select the information to see from caption item of pop up menu.

<Note>

If the user selects QCIF mode to monitor under low leveled system frame rate would be also low.
In this case uncheck “caption” on option menu and it will raise frame rate.

2.5.6. Image transmission speed

User can control an image transmission speed with Frame Rate of pop up menu.

2.5.7. Image resolution

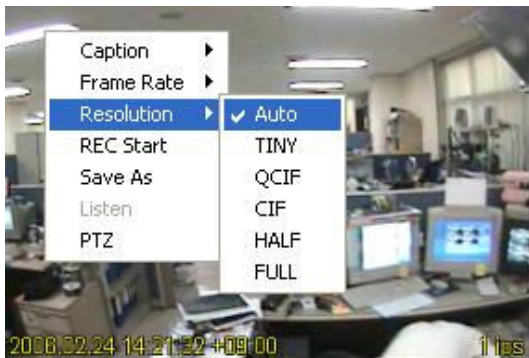

Change of resolution will be necessary to suit monitor size, if setting resolution “Auto”. The Selected resolution will be applied regardless of monitor size, if setting specific resolution.

2.5.8. Stream

In case of monitoring the model supports Mpeg-4, it shows the selectable menu for stream as follow..

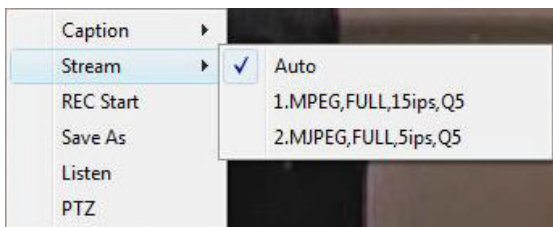

If it set to Auto, it shows adjusted resolution to capacity of PC and window size of monitor.

Unit serves the closest stream to the resolution required.

But, if it selects specific stream, it shows the stream as required irrelevant to window size & capacity.

<Note>

The below table shows the number of channel by each resolution with MPEG4 Stream which can be monitoring from Control Center Program.



Resolution	Number of Channel
QCIF	32
CIF	8
HALF	4
FULL	2

(* In case of each stream with 30ips)

In case of MPEG4 Streaming from Control Center Monitor Program, It supports up to 60ips with full size monitoring. And it will output each picture per second In case of user request more than 3 with full resolution.

The Control Center Program will not support maximum image output (support one picture per second), if the user's PC has lack of performance.

2.5.9. Event

When the "MD" occurs,  icon will appear. When the sensor is on,  icon will appear with sensor number.

2.5.10. Saving image

Saving live image

Select "REC Start" from the pop up menu or click recording button . The recording hour is also put on record. The maximum storage hour is 10 minutes. User can set drive to store in REC tap of the "Tools> Options" menu.

Saving still image

User can save current image as file format of bmp or eye with "Save As". Eye file can be seen with Microsoft Internet Explorer. User can select saving method and if automatic saving is selected, he can select recording drive and file format for saving (If manual saving is selected, user will select above details when selecting "Save As")

2.5.11. PTZ control

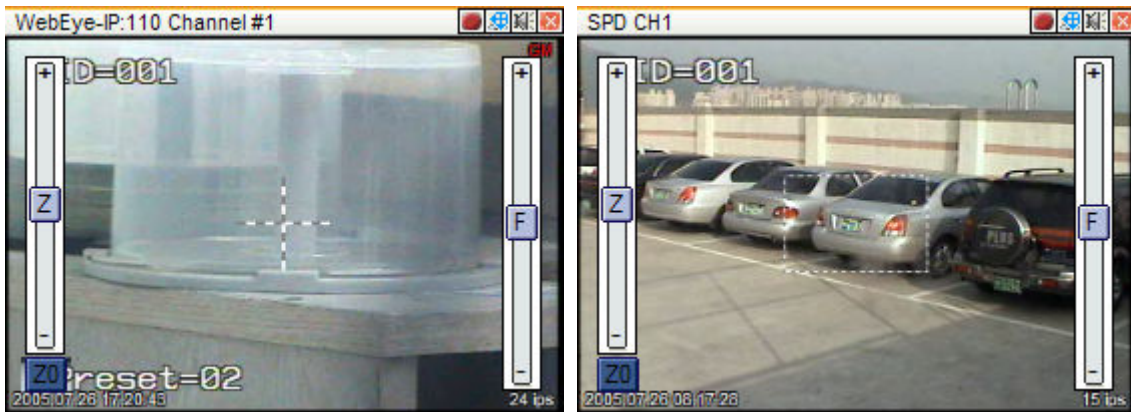

Pan/Tilt control

Select PTZ menu from pop up menu or click on  button. The method of PTZ control is different between units. In case cruciform line is seen in the center of screen, user can activate Pan and Tilt with a mouse. When user moves it to the left/right direction from the center, user will have control of Pan. When user moves it to the top/low direction, user will have control of Tilt. The further user moves it from the center, the faster Pan/Tilt moves.

Control of Area Zoom In

In case user can see a dotted quadrangle, it is a mode that user may zoom specific area. Drag and drop “Zoom In Area” with a mouse. Interface will be changed to enable the unit to execute “Area Zoom In”. Click a mouse while pressing “Shift” key if wanting to execute normal Pan/Tilt in “Area Zoom In” mode. Basic mode will be changed to normal control mode if selecting “Normal PTZ Mode” of pop up menu.

Zoom /Focus control

If user moves mouse to the left edge or to the right edge, user can see the window for Zoom and Focus. The unit where user can use “Area Zoom In” has “Zoom Zero” button.

Preset moving

If preset is set, “Goto Preset” is additionally indicated in the pop up menu. When user selects specific preset position among preset list, user can move to it.

Auxiliary control

If preset is set, “Auxiliary” is additionally indicated in the pop up menu. If user selects registered menu, the proper action will be accomplished.

Group mode

If user enables PTZ to operate when group mode (GM) is activated, group mode will be displayed in upper right corner of screen.

2.5.12. Audio control

If an audio is linked to channel, “Listen” of pop-up menu or audio button will be activated. The initial audio mode is mute. Select pop-up menu or button to listen to audio. Cancel mute mode and control audio volume. Mixing audio from multiple channels can be possible.

2.5.13. Close all





When clicking on  button, all connected monitors will be closed. When clicking on the button of map mode, all map windows will be also closed.

2.6. Alarm log

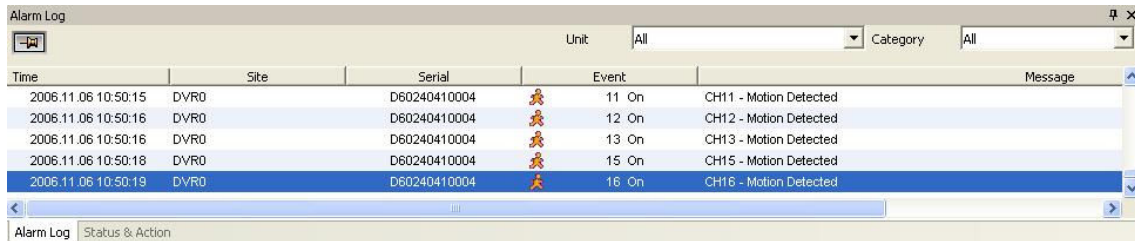
Events from registered units are listed up real-time in the lower part.

2.6.1. Event information









Time	Site	Serial	Event	Message
2006.11.06 10:50:15	DVR0	D60240410004	 11 On	CH11 - Motion Detected
2006.11.06 10:50:16	DVR0	D60240410004	 12 On	CH12 - Motion Detected
2006.11.06 10:50:16	DVR0	D60240410004	 13 On	CH13 - Motion Detected
2006.11.06 10:50:18	DVR0	D60240410004	 15 On	CH15 - Motion Detected
2006.11.06 10:50:19	DVR0	D60240410004	 16 On	CH16 - Motion Detected

The event type is indicated as an icon and event number. “On/off” and event number are also indicated.

‘Keep Visible’ button on the left upper of the screen performs as toggle and if selecting() , it will keep selected details displayed. This means it will not be effected by new event information.

(Table. Event icon)

Button	Function
	Motion detect on/off
	Sensor input
	Relay output on
	No video/ video detected
	Text input
	Authentication Fail
	Configuration Changed

User can classify events according to unit and category.

2.6.2. Viewing image

User can see an event image with double click of list. When Motion detect is set up, only the triggered channel is played. However when sensor or relay is set up, all channels of the triggered unit are played and screen is divided according to the channel number of unit.

If user selects the playing channel, monitor focus will be moving towards relevant unit and if in map mode, window will be popping up.

2.6.3. Viewing Detailed Message

Some part is printed out as for long message. If want to see full message, click Show Message menu after pressing right button of mouse in the message column. Then message box will appear as below.

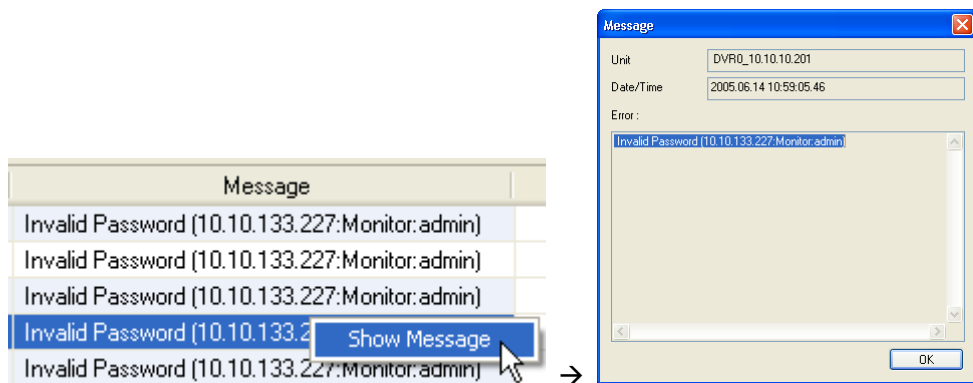

2.7. Status & Action





Select the “Status & Action” tap of event view.

Unit	MD/No Video	Sensor Input	Relay Output	T... R...	Alarm Notify	Time
NTP Server_both_192	🚫🚫🚫🚫🚫🚫🚫🚫	📡📡📡📡📡📡	🔌🔌🔌	🔑📧	As Schedule	2006.11.06 10:50:15
Aging_M5400_200	🚫🚫🚫🚫🚫🚫	📡📡📡	🔌🔌	🔑📧	As Schedule	2006.11.06 09:23:24
412_196	🚫🚫🚫🚫🚫🚫	📡📡📡	🔌🔌	🔑📧	As Schedule	2006.11.06 10:48:35
M5400	🚫🚫🚫🚫	📡📡📡	🔌🔌	🔑📧	As Schedule	2006.11.06 10:13:43
DVR0	🚫🚫🚫🚫🚫🚫🚫🚫	📡📡📡	🔌🔌	🔑📧	As Schedule	2006.11.06 10:51:11
M5400_211.53.133.232	🚫🚫🚫🚫	📡📡📡	🔌🔌	🔑📧	As Schedule	2006.11.06 10:17:38
DVR0_211.53.133.89	🚫🚫🚫🚫🚫🚫	📡📡📡	🔌🔌	🔑📧	As Schedule	2006.11.06 10:51:06

2.7.1. Status& Action information

This tab has all the information of registered unit such as MD, No Video, sensor and user can also accomplish orders such as relay out and audio out. As for audio out, user can transmit this order to many units at the same time. Also present time of each unit is indicated.

(Table. Icon)

Button	Function
	Motion Detect On, Channel Enable, No Video, Channel Disable
	Sensor Input
	Relay Output Disable, Off, On
	Talk Off, Talk On
	HDD status
	Not Recording / No Error
	Recording / No Error
	Not Recording / Error
	Recording / Error
<input checked="" type="checkbox"/> As Schedule ,	As Schedule : alarm notification is according to schedule in the Option
<input checked="" type="checkbox"/> Always On ,	Always On : alarm notification is always allowed
<input type="checkbox"/> Always Off	Always Off : alarm notification is not allowed

2.7.2. Viewing image

User can monitor all channels with double click. Screen division will be changed according to the number of channels. In map mode, “Live Viewer” window is popping up.

2.7.3. Alarm notification setting at each unit

Alarm notification can be set according to each unit in the Alarm Notify column. Three modes (Always On / Always Off / As Schedule) mean that when alarm is triggered, the notice is always allowed / notice is not allowed / notice is according to schedule in the option. Setting value is changed by order of Always On / As Schedule / Always Off, when clicking. At this time alarm message setting and schedule edition can be done in Alarm Notify tab of Tools > Options...menu.

2.8. Automatic image switching

In unit mode and view set mode user can accomplish automatic image switching at a designated period of time. User can select all screen switching or Monitor 1 Only switching. In case of view set mode switching will be done by each view set. Switching period can be set at Sequential Switcher of Tools> Options. In case of Monitor 1 Only checked in the site mode, the switching will be done at only the first monitor and current image mode will be kept at the other monitor. User can not do things such as registration, deletion, edition of view set and unit during switching.

2.9. Alarm pop up

User can open alarm pop up at “Alarm Popup On/Off”  of tool bar menu or option configuration. The relevant channel or unit will be monitored automatically when event such as MD, sensor is occurred. It pops up during set time. If alarm image disappear, user will see states before alarm pops up.

2.10. Event search

All event information which is transmitted to the Control Center will be stored. User can search event log according to unit, time, and category. User should click on “Event Search Utility”  of tool bar menu in order to execute it.

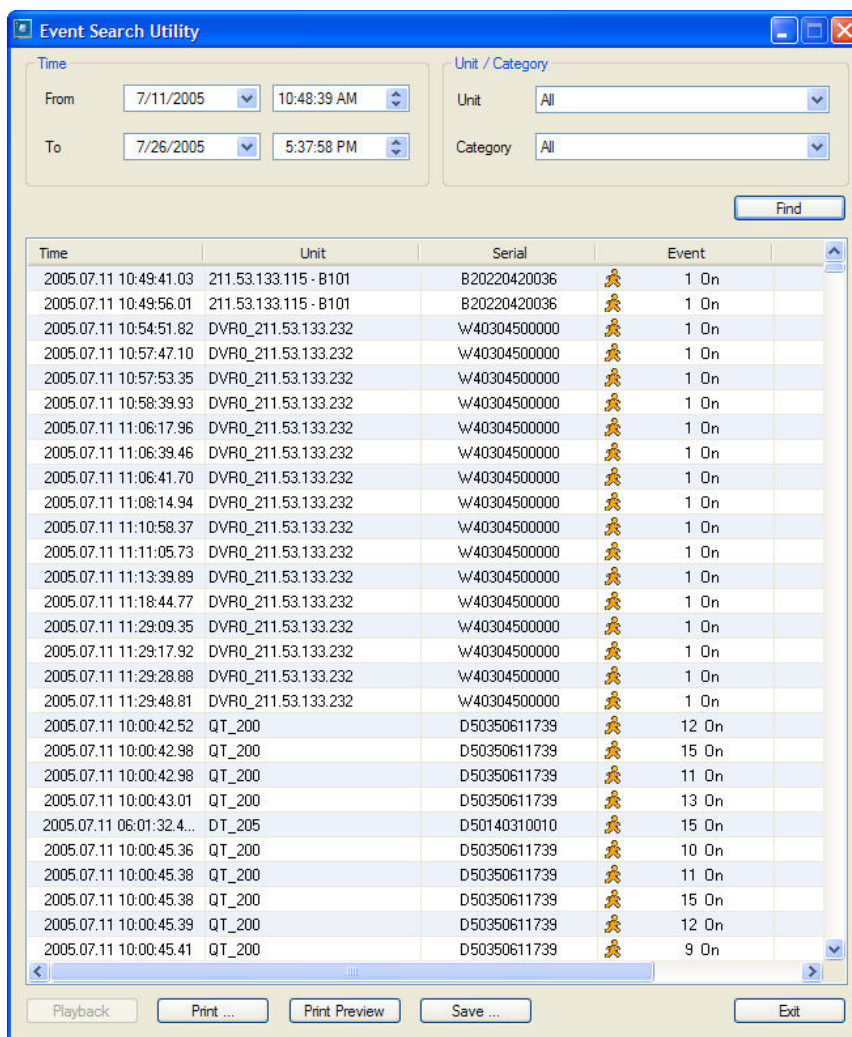

When user inputs conditions of search and click on “Find” button, result of search will be listed up. And playback button of unit which can be searched will be activated when a row was selected.

2.11. Program user configuration

Select “Admin> Users and passwords” menu.

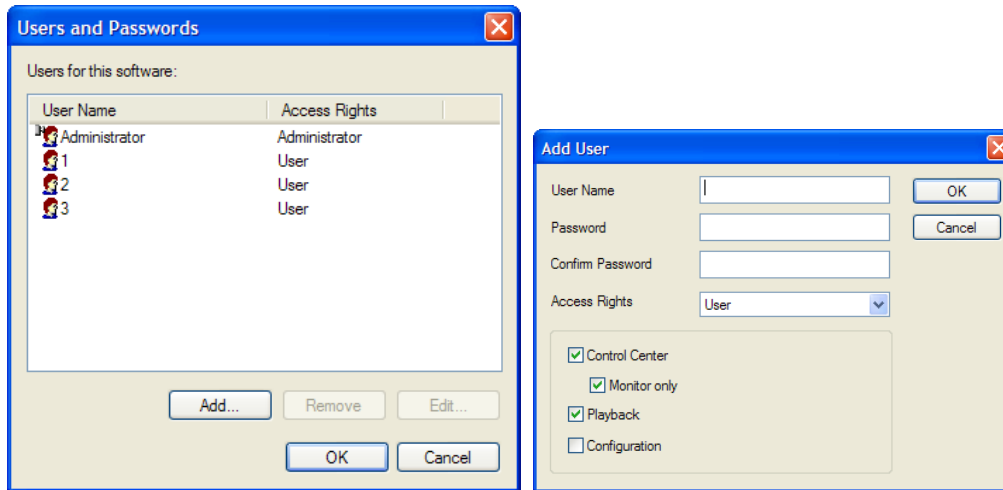

Click on “Add” button if user wants to add user account. User can set authority relating to Control Center, Playback and Configuration program. If user has only the authority of monitoring, user can not accomplish setting relating to unit, view set, mapping, managing user.

2.12. Option setting

User can set option of many functions if user selects “Tools>Options” menu.

2.12.1. Caption

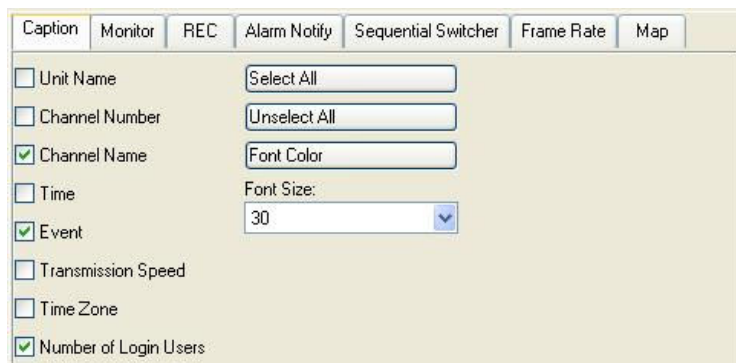

Select caption information which will appear in monitor view and user can set unit name, channel number, channel name, time, event, display speed, time zone information and number of login users.

User can adjust the color and the size of font of caption information.

2.12.2. Monitor

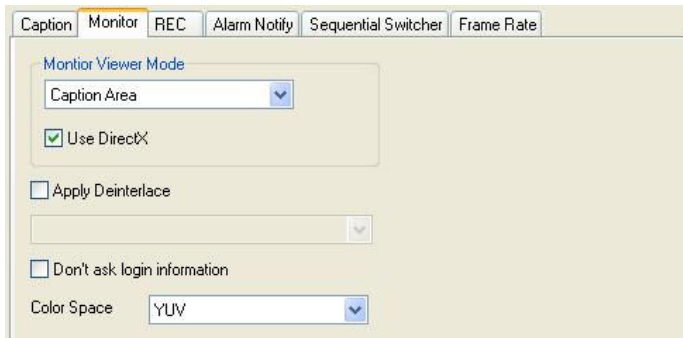

Dual monitor

When user wants to use dual monitor, Control Center can support this function.

Select “Dual Monitor” of monitor tab.

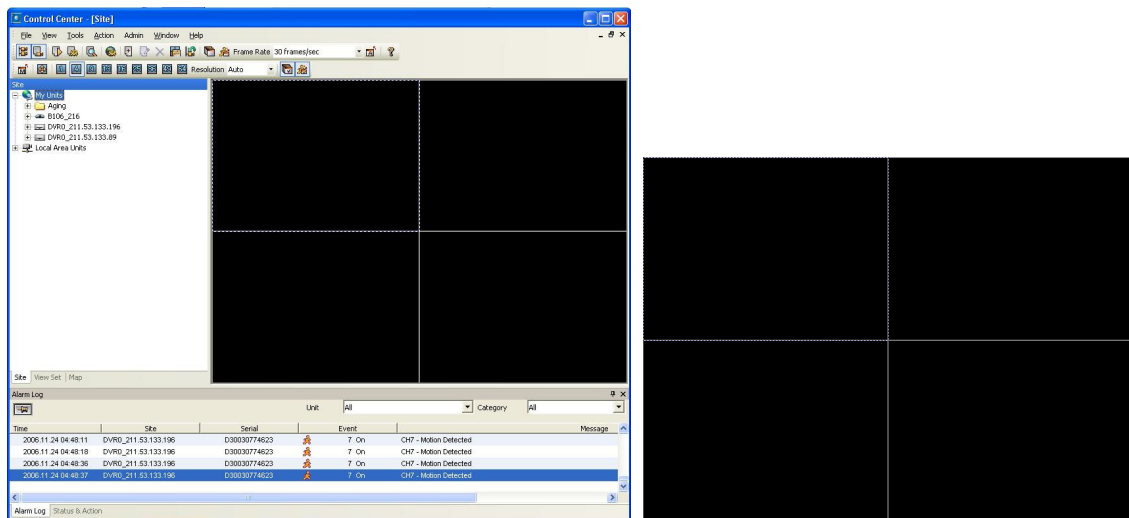

When running the program, window for viewing will be popping up on the screen of second monitor.

User can view image with second monitor. Channel and unit will appear on the screen of second monitor when user uses map mode.

View mode

User can see a full image in “Full” mode. User can see image size according to CIF resolution ratio in “Ratio” mode. As for “Caption Area” mode, caption area is indicated on top of image and image is displayed in the left area according to ratio. As for “Use DirectX Mode”, an image is displayed with “Direct Draw”. The higher quality graphic card user uses the better image it can show.

Deinterlace

Deinterlace On /Off

Color space

MPEG4 stream of ControlCenter program can produce 120 fps at full size of YUV mode while 60fps at full size of RGB mode.

When more than 5 YUV mode/ 3 RB mode of full size video is requested, only 1fps is available.

<Warning>

However, function of monitoring might be limited by system function (CPU, graphic card, memory)

2.12.3. Save

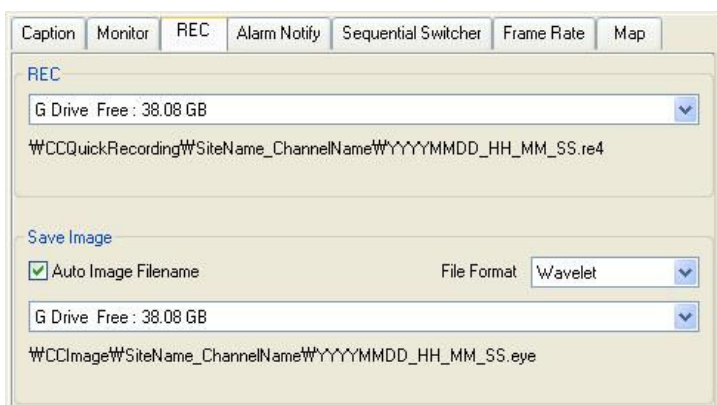

Select the drive that will store moving image file with “Quick Recording”. After finishing it “CCQuickRecording” folder will be created in the selected drive and “re4” file will also be made. Folder name consists of Unit name_channel name, and re4 file will have name for the date.

Select the drive that will store moving image for setting ‘Save as’ automatic.

Select the file format of recorded image (BMP, Wavelet (eye)).

“CCIimage” folder will be created in the selected drive and “re4” file will also be made. Folder name consists of Unit name_channel name, and re4 file will have name for the date.

2.12.4. Alarm

The screenshot shows the 'Alarm Notify' configuration window. It features a tabbed interface with the following sections and controls:

- Alarm Pop-up:** Radio buttons for 'On' and 'Off' (selected). A 'Duration Time' spinner is set to 10.
- Buzzer:** Radio buttons for 'On' and 'Off' (selected). A 'Duration' spinner is set to 5.
- Live Monitor Blink:** Radio buttons for 'On' and 'Off' (selected).
- Alarm Log:** Radio buttons for 'On' (selected) and 'Off'.
- Checkboxes:** 'Play with section' (unchecked), 'MD On' (checked), 'Sensor Input On' (checked), 'Text Input' (checked), and 'Fix Division' (unchecked).
- Buttons:** 'Alarm Notify Schedule...' and 'Sensor-Channel Mapping...'.

Alarm Pop-up

To pop-up alarm mode user should set it as 'on'.

User can select or set MD, Sensor and Text while alarm pop-up is performing. It will perform according to selected event.

Unselected event would not perform even if alarm pop-up is set as 'on'.

Duration Time

User can see an event image during the time.

Fix Division

User can fix the division of monitor screen at alarm pop-up mode.

Buzzer

When the information is transmitted to alarm log, user will be notified by sound. User can hear buzzer when repeated number of event satisfies designated count.

Live Monitor Blink

Decide whether to draw red outer line on the image when alarm is occurred.

Alarm Log

Decide whether to indicate event in the alarm log. Even if set as "off", important event (Authentication fail, defective HDD, etc) will be indicated.

Sensor Channel Mapping...

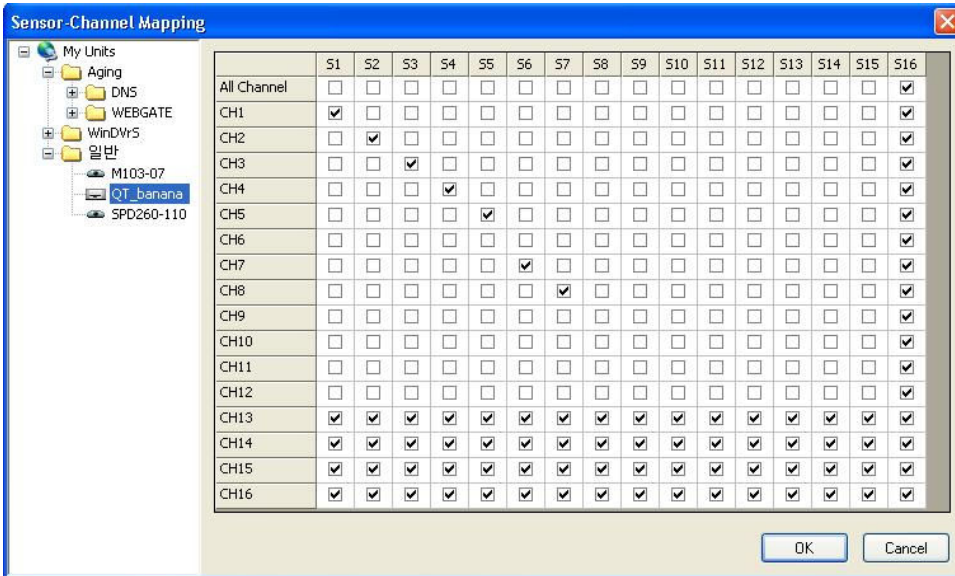

User can designate the channel which will pop up according to each sensor. If user selects the unit in the tree, the window for mapping sensor and channel will appear in the right part of screen. The selected channel will pop up when sensor is triggered.

<Sensor Channel Mapping Example>

1. S1 - CH1, CH2 : When S1 is triggered, CH1 and CH2 will pop up.
2. S1 – All Channel : When S1 is triggered, all channel will pop up.

Alarm Notify Schedule...

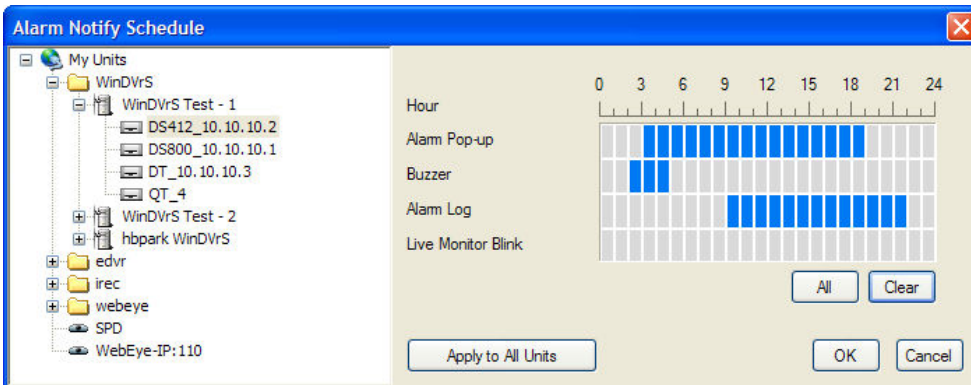

Click the button to edit alarm notify schedule according to each unit as above screen. Select unit and set notify mode On(blue), Off(gray) at each unit. Click “Apply to All Units” button to apply the edited schedule to all units. Click “All” button to set all schedule as all mode on and click “Clear” button to set all schedule as all mode off.

2.12.5. Automatic image switching

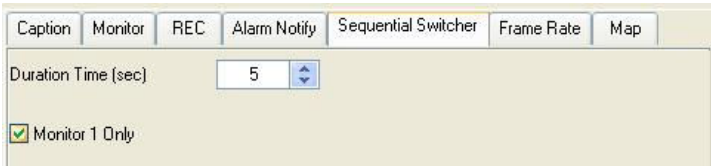

If user selects the function of image automatic switching, user can view an image as much as the number of divided screens at unit mode and can view an image by view set at view set mode. The image switching is done according to “duration time”.

Monitor 1 Only

If checking Monitor 1 Only and selecting automatic image switching, only Monitor 1 will perform that function at unit mode. This function can not support view set mode and map mode..

2.12.6. Frame Rate

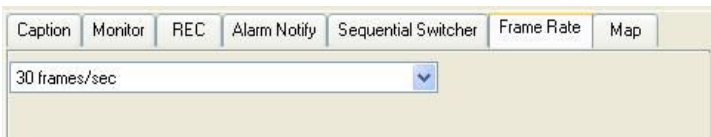

User can set the frame rate of all monitor images.

2.12.7. Map

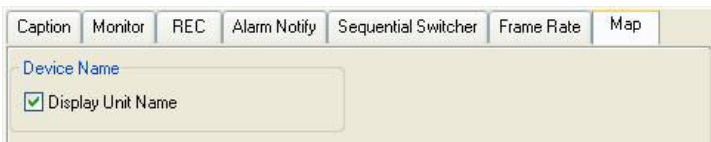

If checking Display Unit Name, unit name will be displayed together with registered device name in the map.

3. Control Center Playback

User can search and view things such as image, audio, text which are stored in unit. To playback them user should select “Tools>Playback” menu.

3.1. Interface

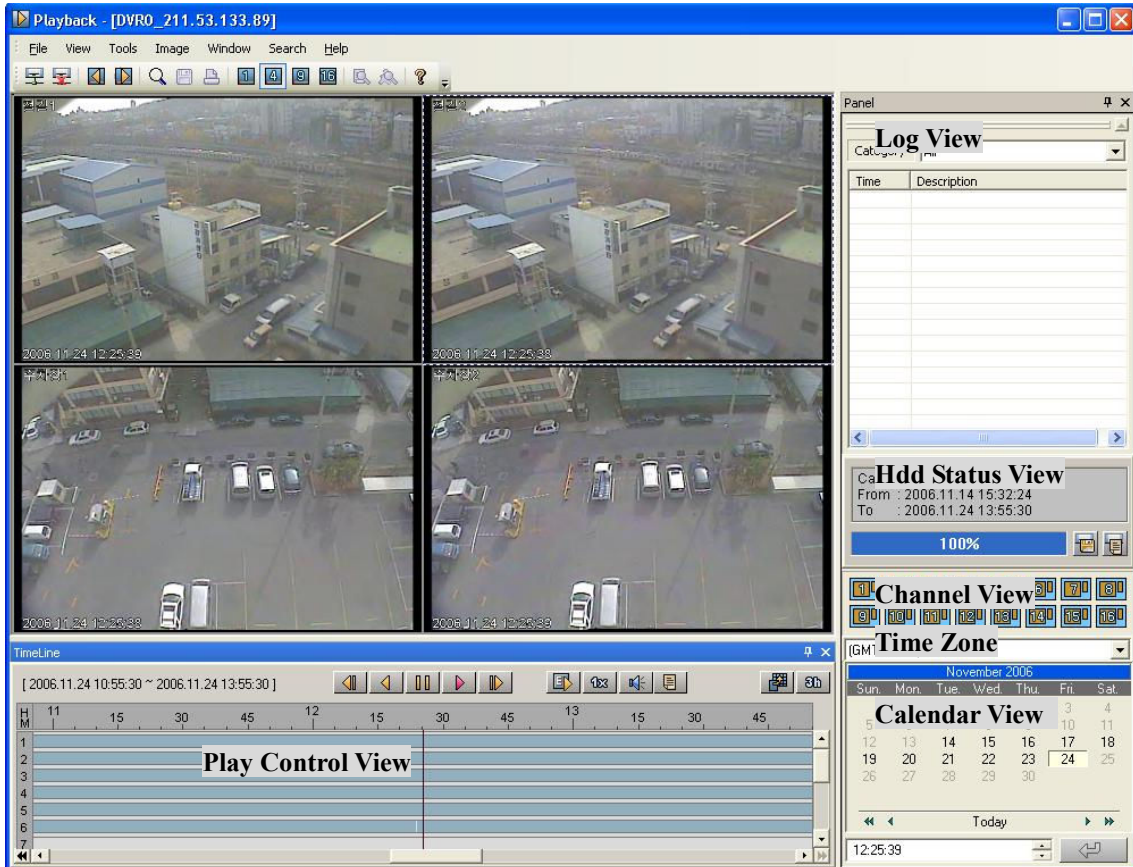

3.1.1. View area

Play Control View

There is a function of view control. It shows user recording status through bar.

Log View

It shows a log in designated area, also shows according to category. When user double-clicks log view, it will pop up and close of pop up view will lead to original mode.

HDD Status View

It shows the used space and free space of HDD, also shows the stored time area.

Channel View











Select the channel user want to playback.

Calendar View

It is possible to change search section into specific time zone.

3.1.2. Tool bar

(Table. Playback Tool Bar)

Button	Function
	Opens unit or stored file
	Closes connection
	When there is a channel exceeding screen division which is selected, user can select one as much as number of divided screen. At this time this button is used for moving to previous selected screen.
	When there is a channel exceeding screen division which is selected user can select one as much as number of divided screen. At this time this button is used for moving to next screen.
	Dialogue box for controlling “Zoom In”, “Brightness”, “Contrast”.
	Stores image of selected monitor.
	Prints image of selected monitor.
	Divides monitor screen with 1, 4, 9, 16. Can search maximum 16 channels at the same time.
	Search Text
	Search image with motion after designating Motion Area
	Confirms information of Control Center version.

3.2. Opening unit/backup file

First of all user must select “File> Open” menu (). User can see the unit tree which is registered in “My Units” by using Control Center. But user can see only the unit that is possible to search because of having HDD among registered units. If user wants to search the unit, user must select it and click on “OK” button. If user wants to search backup file, user must press “Open Backup File” button and select it user want to search. When user opens unit and starts searching process, user can search it from the time of the last day which was stored in unit. Search section is adjusted according to the hour when it is stored at last day. (If the volume of 4 hours is stored, search section will be 6 hours)

3.3. Search

3.3.1. Image information indication

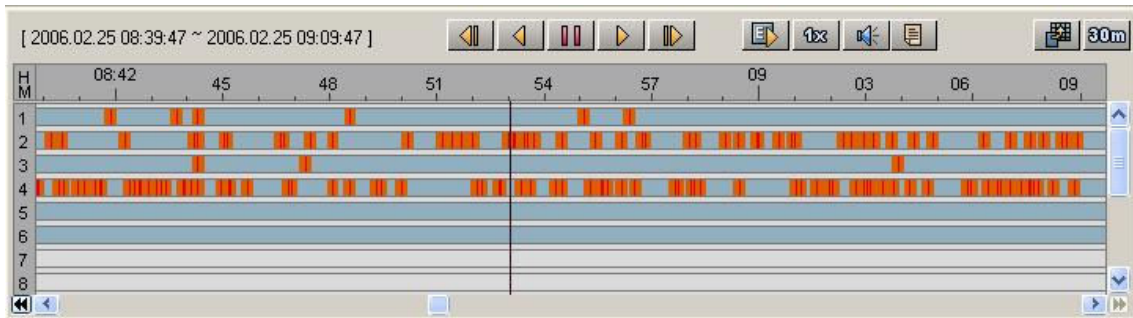

The image information which is stored in each channel has different concentration line according to the number of stored frame. (The higher the recording speed is, the deeper log color is) The red colored line indicates event image (Motion Detection, sensor), the line having red color before and behind indicates “Pre Alarm/Post Alarm”. The scroll bar of the lower part has different length between searching sections on the basis of 24 hours.

3.3.2. Change of search section

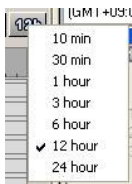

When pressing button of upper right corner, the menu for changing search section will pop up. The search section can be changed such as 10 minutes, 30 minutes, 1 hours, 3 hours, 6 hours, 12 hours and 24 hours.

3.3.3. Channel selection



The channel where the search can be done is activated. Press the button to select channel.

3.3.4. Calendar search

User can move search section to specific date in pause mode. Press the date of calendar or press  button after inputting wanted time.

3.3.5. Log information indication & Search

User can see a log list which is within search section at log view. Log list shows only the log relevant to the channel that is being searched and user can see it according to category. User can move to relevant time zone with double click of log in log list.

3.3.6. Text search

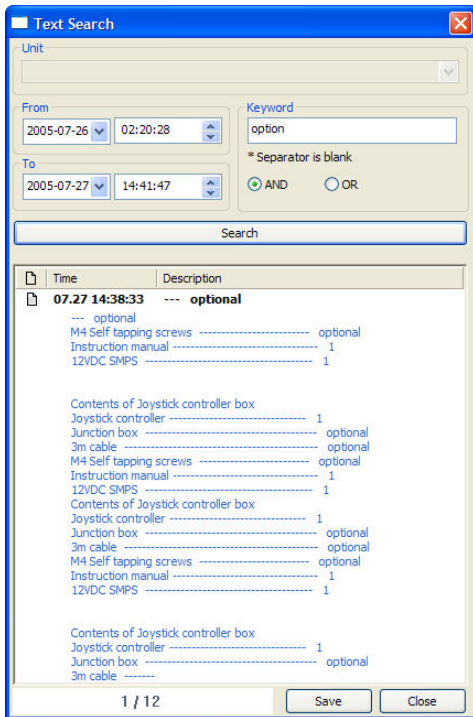

User can search text within specific time zone.

As for DVrS, combo box where user can select unit will be enabled. Press “Search” button after selecting search section, keyword and filter condition. Then text will be listed up. While search is going on, “progress” appears in the lower part and when searching comes to an end it shows the number of text filtered by keyword among total texts.

User can save all the text in “txt” file format by clicking on “Save” button, also can jump to the relevant time zone by double clicking searched text. While searching text, user can not do other kinds of search. (Motion Area Search, hour jump, playback)

3.3.7. Smart search

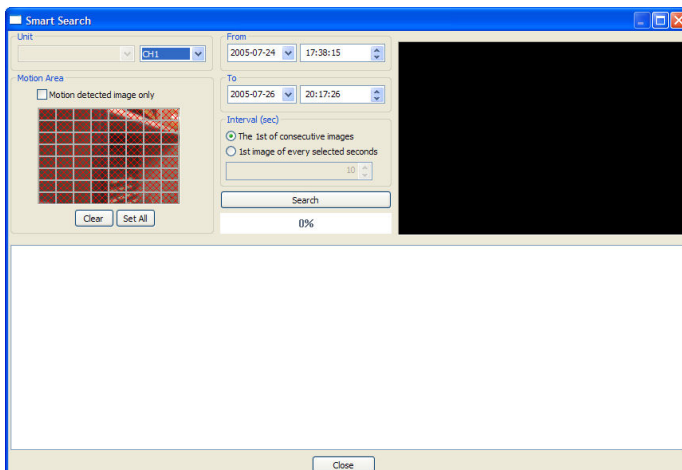

User can search an image that is motion-detected within designated specific time zone.

As for DVrS, combo box where user can select unit will be enabled. Press button after selecting things such as channel, territory, section, intervals that user wants to search. User can search only image that is recognized as motion detection if user selects

“Motion detected image only” menu. (MD is set in configuration program) It will check all images if user sets “Interval” 0. It will show an image at designated intervals if not.

The snapshot of the searched image is arrayed. Each snapshot is an image of the time when motion is started. While search is going on the “progress” appears in the lower part of screen and when the search comes to an end, user can find the number of the total image which is searched. User can view the image on the right top of screen by clicking searched image. Double clicking will lead to jumping to searching

time zone. While search is going on, user can not do any kinds of search. (Text search, hour jump, playback)

3.3.8. Thumbnail search

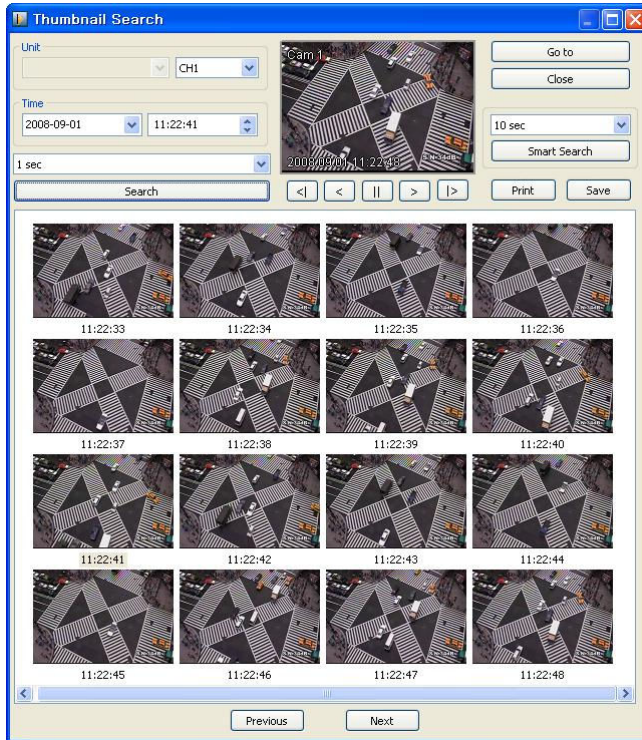

Select channel to search, standard time and press “Search” button. Recorded images in a second are indicated on the basis of standard time at bottom area. Select wanted interval from combo box to control the interval of thumbnail time, and select “Search” button

Based on the standard time in lower area, it indicates recorded image every a second. Select wanted interval from combo box to control thumbnail time interval and select “Search” button. It can select the interval of time in 1 second, 1 minute, 1 hour, and 1 day.

If it selects each thumbnail through mouse, the time of playback view at top is moved.

Through <| (Play a frame back), < (Play backward), [] (Stop), > (Play forward), (Play a frame ahead) buttons, it can view image playback.

Select “Go to” button so as to move to present thumbnail search view of Playback program time.

Through “Smart Search” button, it shows the window for smart searching in the standard of thumbnail search view time.











If select “Previous” button, it searches previous time image recorded than present thumbnail shown.

Select “Next” button to search next image recorded of present thumbnail.

3.4. Playback

3.4.1. Playback button

(Table. Playback control button)

Button	Function
	Playbacks previous one image
	Playbacks backward
	Stops playback
	Playbacks forward
	Playbacks former one image
 / 	The former button playbacks whole image, the latter playbacks only event image
 ~ 	Designates playback speed. (0.5x, 1x, 2x, 4x, 8x, 16x, 24x, 32x, 64x, All) “All” is to be a mode which playback all stored images. Playback speed (except “All”) is close to real-time but its performance may be vulnerable to network condition.
	Can decide whether it displays recording status of all channel of unit or recording status of only selected channel.

3.4.2. Audio playback

Audio will be available when user playback forward at the speed of 1x. User can play audio of all channels which are presently in playback. When user wants to turn off audio, tune in volume, playback specific channel, click on  button. When there is no stored audio source, “only” check box for selecting specific channel is disabled.

3.4.3. Text

The dialogue box of text will be displayed if user press  button. The text transmitted from server will be on screen while playback is going on. Double click of the text can lead user to the relevant time area. User can save it in text file format by pressing “Save” button.

3.4.4. Time zone selection



When user open unit initially, present time zone will be selected automatically and it will show image bar, calendar, log and the information of HDD. User can change time zone.

3.5. Image control

3.5.1. Zoom/Brightness/Contrast control

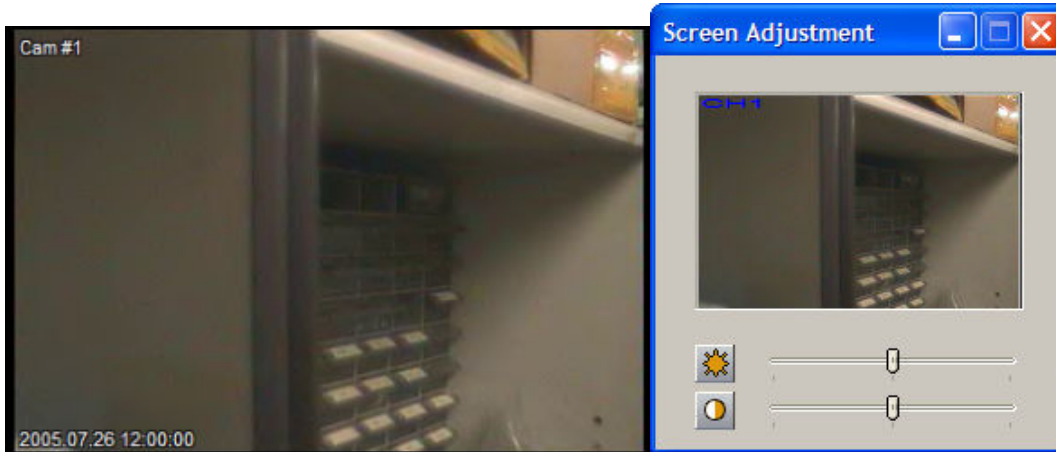
If user selects “Image>Screen adjustment” menu, dialogue box for screen regulation will be popped up. By dragging with mouse, user can designate the territory that user wants to magnify and view.



 can change brightness  can change contrast, and default (brightness 1000, contrast 0) can be set by clicking on each relevant button. Image magnification can be done in a pause mode.

3.5.2. Image save

To save image of selected monitor, user must pop up dialogue box for saving it by clicking “Image>Save” menu. User can save image with memo and caption in bitmap format.

3.5.3. Image print

User can print image of selected monitor together with memo if user selects “Image>Print” menu.

<Note>

1. Paper form of printing out is “A4”
2. Memo can be input maximum 7 lines and within 1 line maximum 45 letters can be input, which can meet paper size.

3.6. Backup function

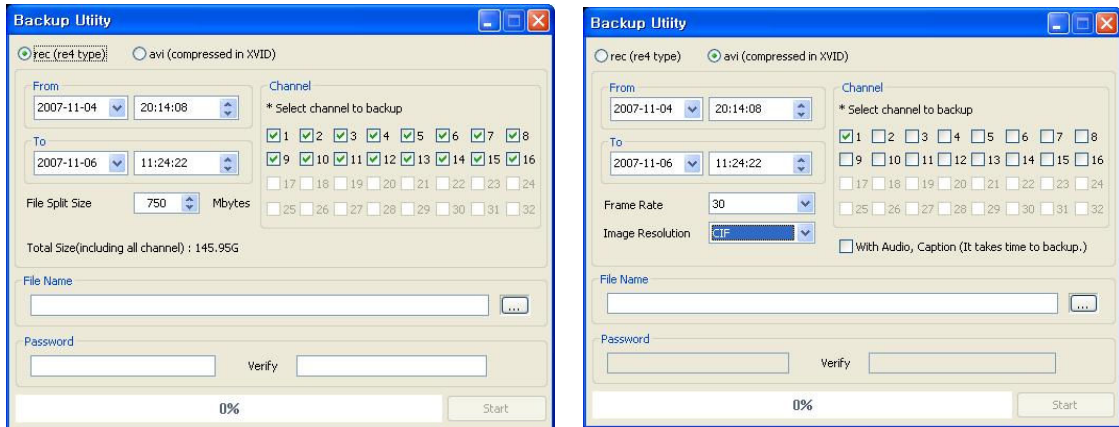

User can execute backup utility by pressing back up button () of HDD status view.

'rec' & 'avi' can be selected. In case of selecting 'rec', it is shown as left figure. In case of selecting 'avi', it is shown as right figure.

'rec' backup can make all channels simultaneously, but 'avi' backup only one channel.

Backup is available per unit. Type backup range (date&time), channel, file division size, file name and press "Start" button.

'avi' backup cannot type a password.

3.7. Backup Log function

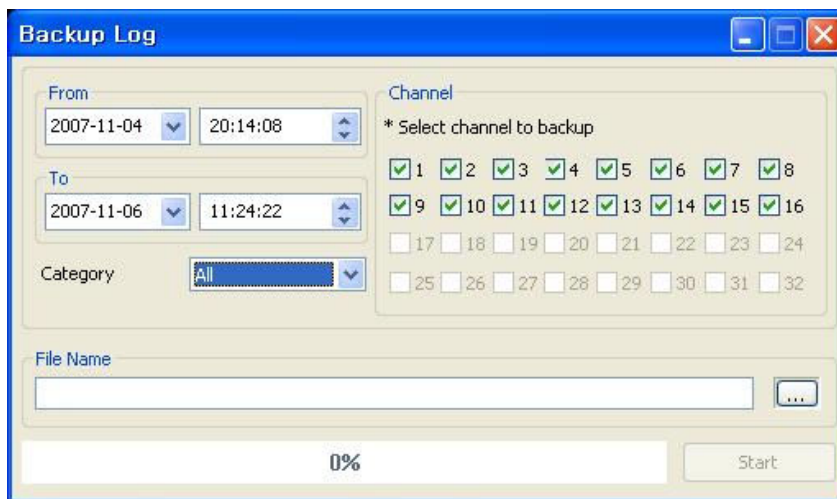

Press () button, then Backup Log will run. This is backup function to make excel file format for log information except for video image.

Type backup period (date & time), channel, file name and press "Start" button.

3.8. DVrS unit search

User can search many units which are registered and stored in the DVrS if connecting to DVrS unit. The tree for channel selection is seen on the right side of screen. Select the unit to search.

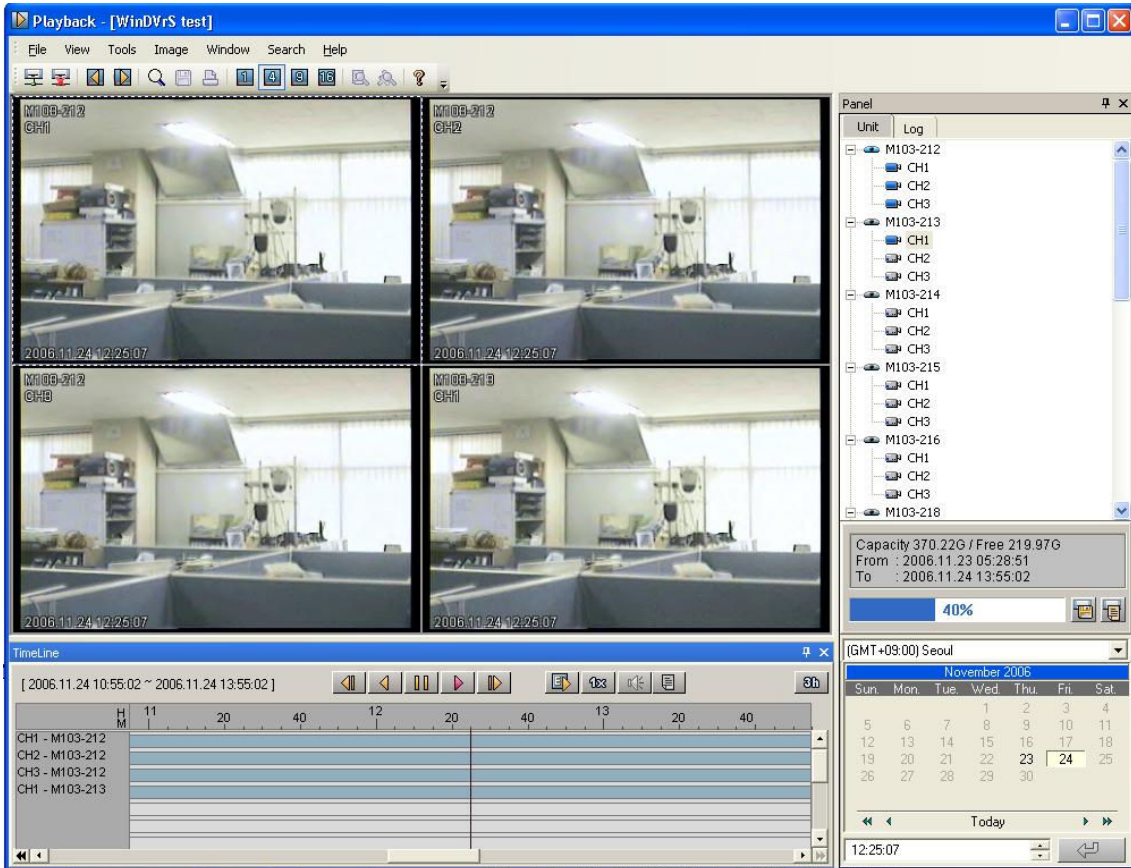

Unit tree

User can see pop up menu when user press the right button of mouse in unit tree.



User can see store information in each unit by selecting “Display Recording Information”. Selection of “Properties” will lead to pop-up window which will show unit information.

Log

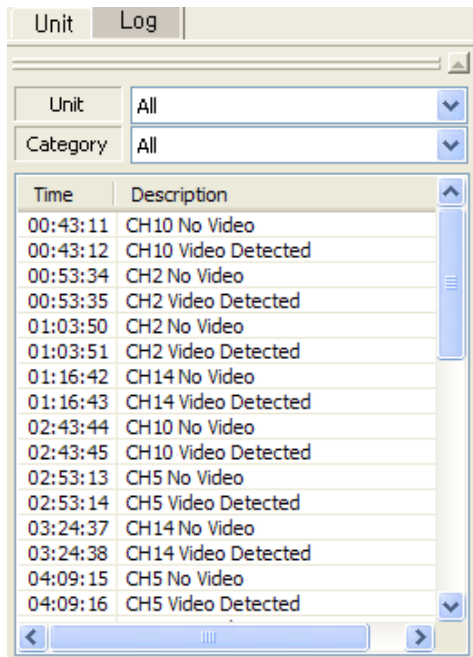

User can see the stored log which is within searched section up to now. User can see it according unit, category.

Adjustment of name area

Selected channel of “Play Control View” is displayed with the format such as “channel name-unit name”.

User can adjust the size of the name with drag and drop of mouse.

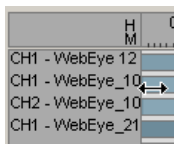

3.9. Option setting

3.9.1. Caption

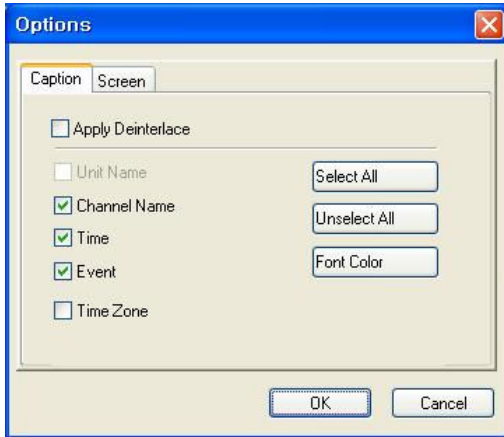

User can decide whether information such as unit name, channel name, time, and event caption will be displayed or not. Unit name will be displayed only if it is DVrS.

3.9.2. Adjustment of screen division

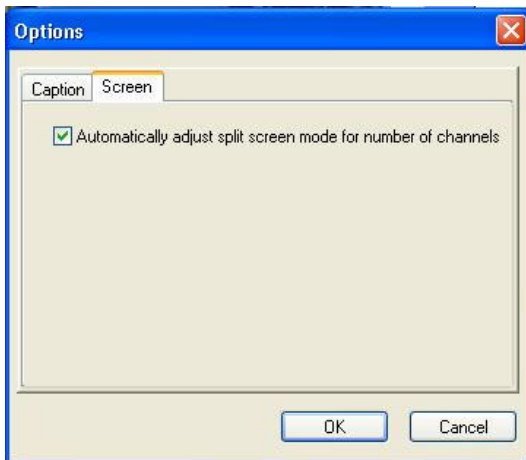

If user selects screen tab, the check box where user can decide if adjustment of screen division will be done automatically will be on screen. Screen is automatically divided to the maximum 16 screens at each choice.

4. Configuration Tools

Configuration Tool enables user to efficiently manage and control all the products which have WESP in it.

4.1. Interface

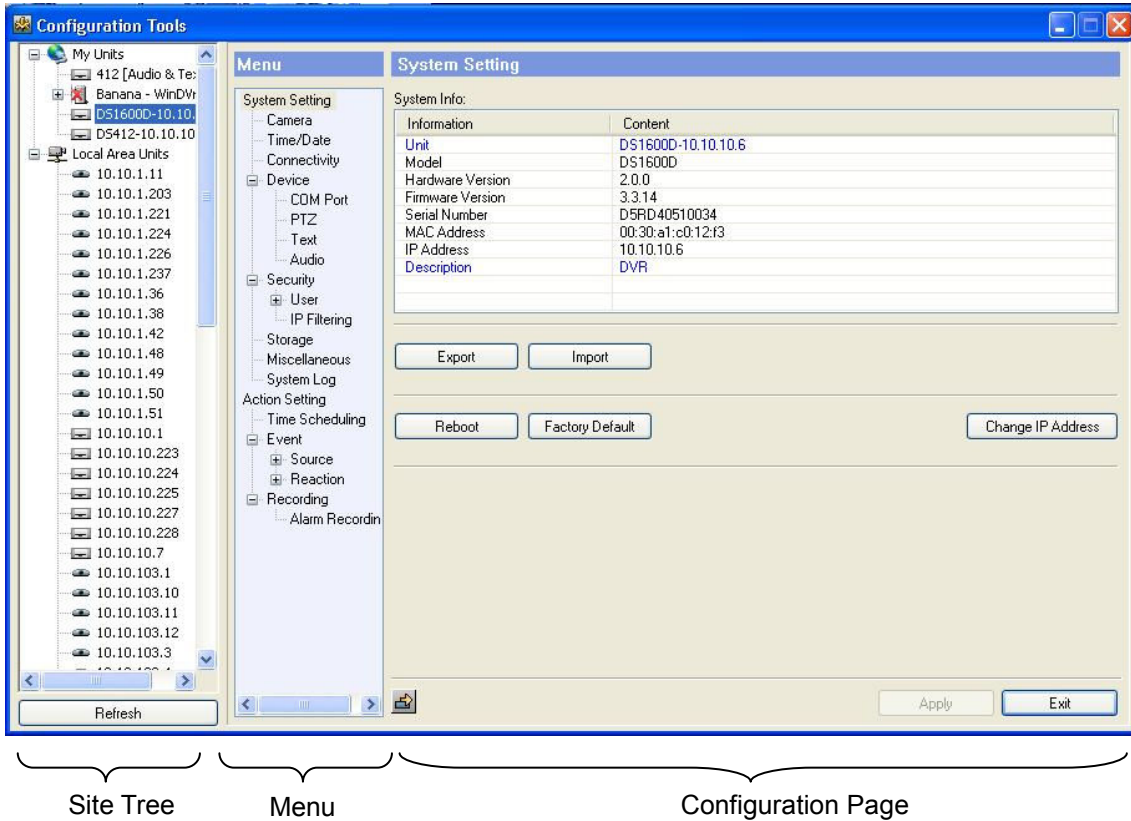

The full screen of Configuration Tool is as above and its contents are such as site tree, menu and configuration page.

4.1.1. Site Tree

The units which is listed in unit tree are registered in main view of Control Center and it is not possible for user to register/delete/revise them using Configuration Tool.

The list is periodically synchronized with “My Units” of Control Center. And when user press the “Refresh” button in lower part, all the information will be renewed rightly.

The details which user can configure will appear in menu if user clicks specific unit. System setting page will also appear default value in configuration page.

4.1.2. Menu

The details of menu are different according to model type of unit. Setting page relating to details will appear in configuration page if user click menu.

4.1.3. Configuration page

As “Apply” button will be activated when user changes configuration of the page, user will just press this button to apply new configuration.

User should press “Apply” button after changing setting of each configuration page.

If user moves to another configuration page without pressing “Apply” button, dialogue box will appear to ask user whether new configuration will be applied.

<Note>

* For the detailed setting information of product, please refer to each manual.

5. Schedule Backup

According to the reserved schedule, schedule backup is program to support the reserved image data at DVR or DVrS including HDD backup at HDD, which is used only for Administrator account and unit registration information.

Backup usually is the work which moves recorded data of HDD to the HDD of another PC.

User can designate the time at his discretion when he wants Schedule Backup to start, and it will perform automatically according to reserved time.

Backup program should be processing in the back ground to start working. If Control Center Installer is installed normally, Schedule Backup program will be registered automatically in the Start program of Windows, so it will be executed at every booting of PC.

Schedule Backup program can work on only one unit at the same hour. Also only one Administrator is allowed to work on one unit at the same hour.

Backup file is created in the specific directory of PC and it can be playback by Control Center Playback program.

<Warning>

However, function of monitoring might be limited by system function (CPU, graphic card, memory)

5.1. Backup setup

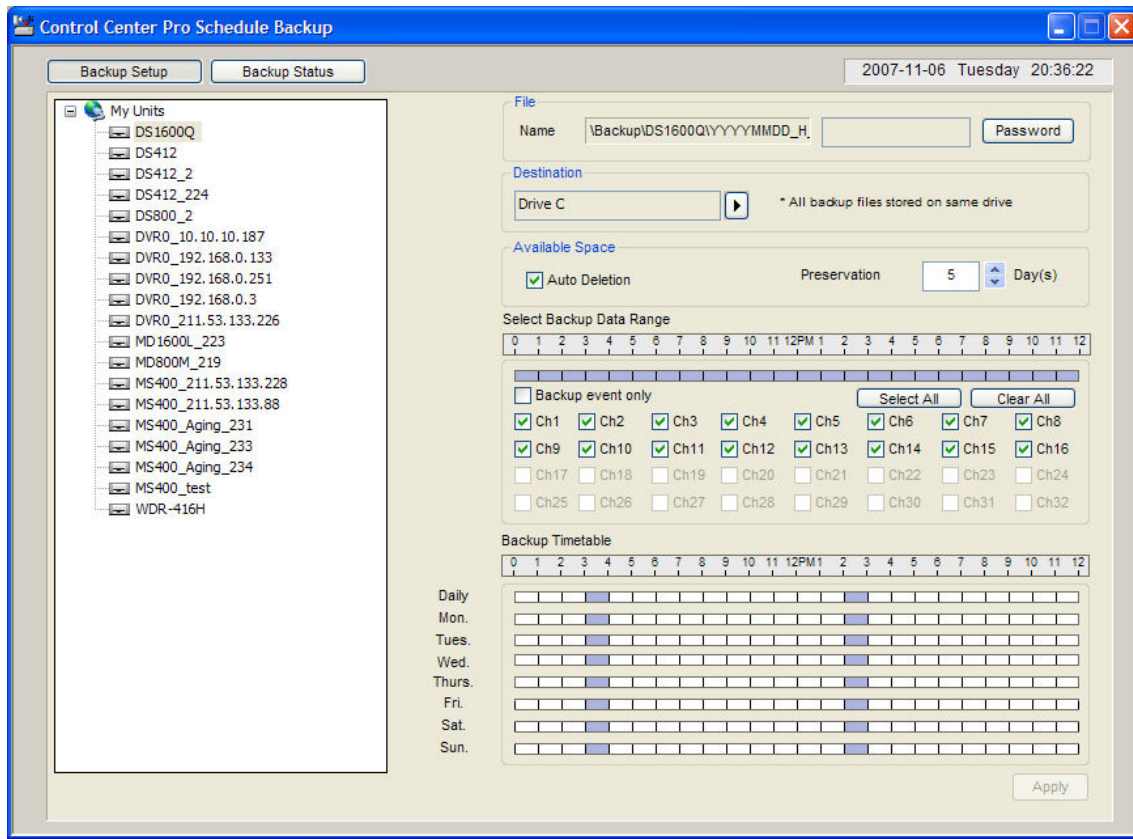

5.1.1. Backup file name

Backup file name is made automatically naming after date and time, its example is as follows.

YYYYMMDD_HH_MM_SS

And backup file is saved in the designated folder in each unit, folder name is made as follows

\Backup\Unit name\.

At this time unit name can be seen in the left tree, and user can change it by using Control Center Configuration Tools.

Warning

* User can not designate the name of backup file or save it in the specific folder.

5.1.2. Password



Created backup file comes to have password, it will play a security role.

Click [Password] button to designate password in the dialogue box.

No password is designated in the initial status. So if user entering password in the first place, it is not necessary to enter 'Old password', just enter password in the 'New password'.

And retype new password to finish process.

Warning

* User should enter the password to playback backup file having password.

5.1.3. Preservation

If backup file of PC amount to exceed the HDD, it would happen to backup abnormally. So it is necessary to delete old backup file of HDD.

It is necessary to designate preservation day for managing backup file effectively. If exceeding designated preservation days, file would automatically be deleted.



To assign backup file preservation, [Preservation] spin button will be used shown as above, which is minimum 1~365 days and default is 5 days.

Overdue backup file would automatically be deleted and there is 3 points of time for checking preservation day.

First point of time is when clicking [Apply] button after setting working time of backup, second point of time is when backup program will be working, third is when message for advising shortage of HDD space appears.

Warning

* Starting point of preservation days is estimated on the basis of recording time of first frame.

5.1.4. Destination

Select the drive to save recording file. If HDD is set as multiple drive, specific drive can be set as dedicated one for recording file.

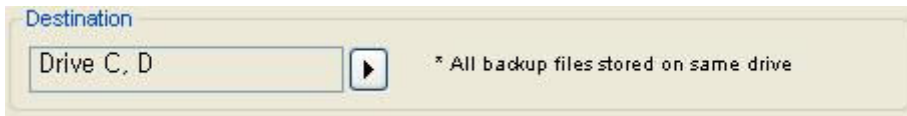

Drive selection can be either one or more. For example, in case of selecting C, D drive, first backup recording is at C drive and next drive will be D drive automatically if C drive is full.

Warning

Backup file of all cameras is saved on the same drive. If designating the drive for saving backup file, all files would be saved on the same one afterwards.

Backup drive per unit cannot be accepted.

5.1.5. Auto deletion setting

In case of not being sufficient for backup capacity at HDD, Auto Deletion Setting is to delete backup data automatically. In case of no backup capacity, it deletes the oldest backup file from several HDD until sufficient backup capacity is fullfill.



5.1.6. Select backup data range

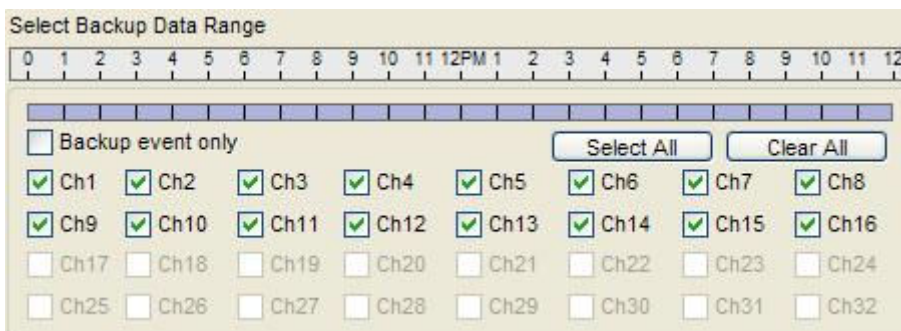

Designate the zone for backup among recorded data of HDD.

The time scope is based on the recording hour. Even if there is data of more than 24hours, user can backup data as much as time scope.

Select the time zone by one hour by clicking. If wanting to unselect it, click the selected again.

User can backup the channel by selecting check box ([Ch1] ... [Ch16]). Default is all channel checked. Activated channel can be backup.

Click "Clear All" to release all channel checked.

Click " Select All" to check all channel activated.

Also if user want to backup only event-triggered data, check the box of relevant channel and mark [Backup Event Only] .

Warning

* Setting such as backup scope, channel and event is all applied to the schedule set on the table of backup working time.

5.1.7. Backup Timetable

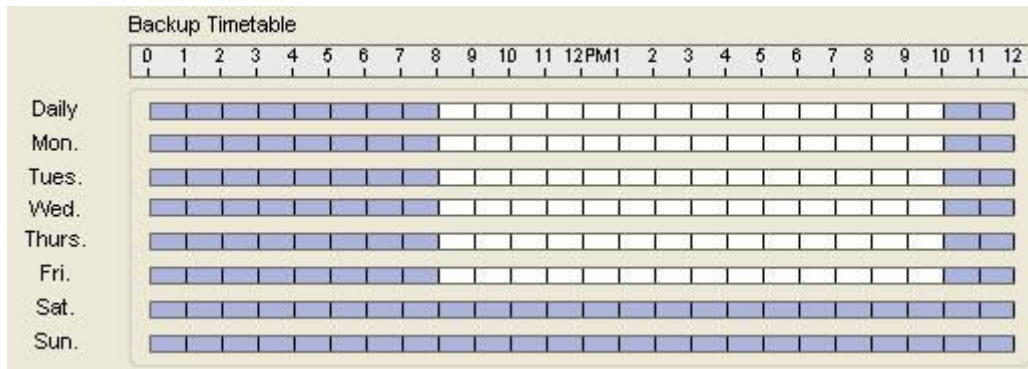

User can designate time and date for backup according to each camera. And designated working time will be displayed in the timetable.

All backup schedules are displayed in the timetable, and the camera schedule during setting is displayed in other color. And not-designated time zone can be set for new schedule. White-bar is non-designated time zone for schedule.

If user locates mouse point on the bloc designated for backup, camera name will be displayed in the format of tooltip.

Timescope can be designated by an hour. Select white block for designation by using mouse. If unselecting

it, click it again with mouse. Backup working is repeated by a week. For example, if designating backup time from 8pm of Monday to 12am of Monday, backup will automatically be performing from 8pm of Monday to 12am of Monday.

User should set 'daily' in the backup timetable to backup the camera daily. If setting 'daily' and schedule, backup will be done according to designated tiem schedule from Monday to Saturday. Therefore, if 'daily' is set, backup will not be done according to day of the week. If user wants to set the schedule according to the day of the week, it is necessary to select the day of the week and designate the time.

Backup is doned during designated schedule and even if it can not finish backup designated scope during designated schedule, it will stop process and start next work.

5.1.8. System Tray icon

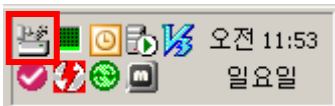

When booting PC, backup program will automatically start and relevant icon will be shown in the system tray. While backup is done, system tray icon will show relevant information.

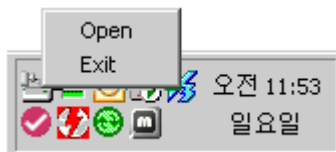

Click the right button of mouse after locate point on the icon of system tray to view the menu.

If selecting [Open] menu, the window for status of backup progress will appear, if selecting [Exit] menu, backup program will be finished in the background.



Enter password to finish the program.

5.1.9. Backup file

As for backup file, relevant file is created by an hour according to each unit.

And it continuously tries to connect to the unit during designated schedule. If it is connected to the unit successfully, backup process will be going on.

Backup process starts at the top of the hour, stops at every 59 minute of the hour.

Warning

* If backup unit of current time schedule is changed during backup, backup progress will be stopped and be newly started.

5.2. Backup status

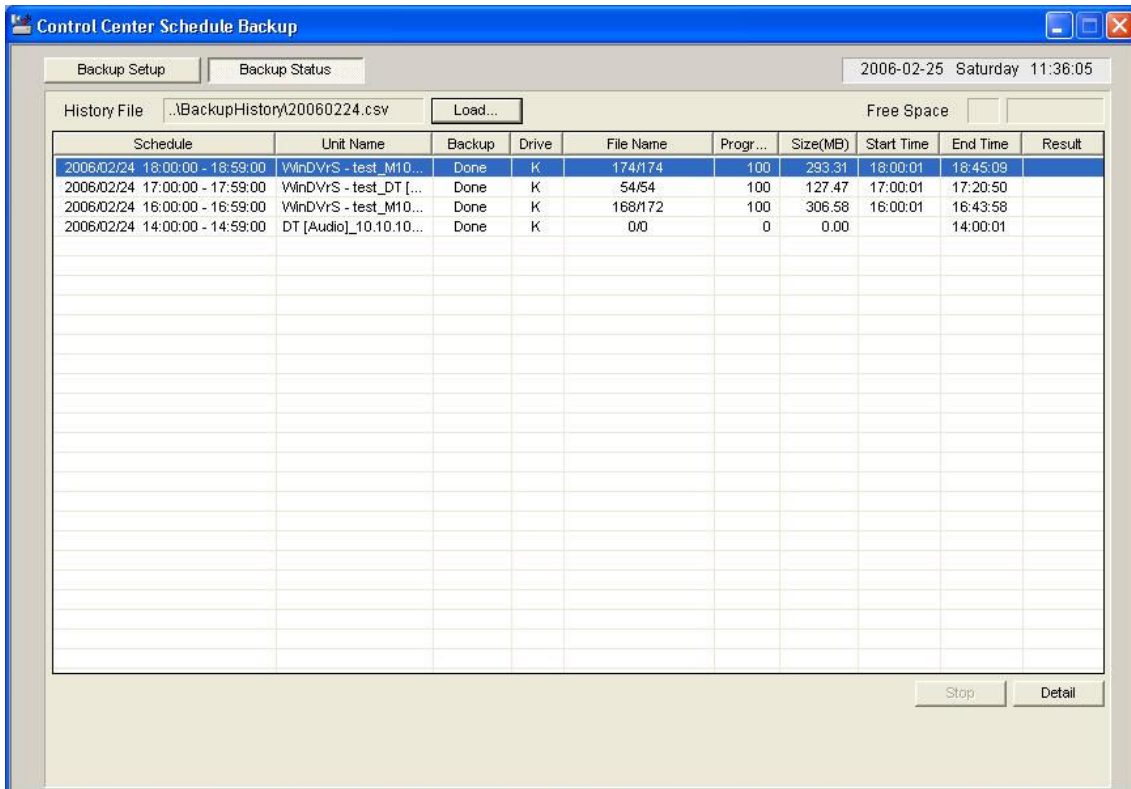

User can check the status of backup progress which is doing in the background by day. Backup start time

and status are displayed in the initial screen.

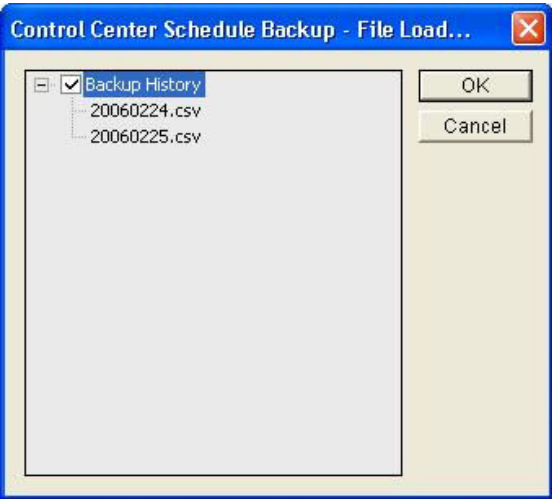

User can search backup history at any time by clicking [Load...] button.

5.2.1. Detailed information

Schedule	Unit Name	Backup	Drive	File Name	Progr...	Size(MB)	Start Time	End Time	Result
2006/01/16 14:00:00 - 14:59:00	DS412-10.10.10.2	Ready	G		0	0.00			
2006/01/16 13:00:00 - 13:59:00	DS1600D-10.10.10.6	Done	G			0.00	13:33:11	13:33:24	0 backu...

Detailed information for backup is displayed in the table.

The information such as ‘Schedule’, ‘Unit Name’, ‘Backup’, ‘Drive’, ‘File Name’, ‘Progress(%)’, ‘Size(MB)’, ‘Start Time’, ‘End Time’ and ‘Result’ is displayed.

In case backup is being done, ‘Working...’ is displayed in the [Backup] menu. User can know how much backup is done through [Progress(%)] menu and how much data is backup through [Size(MB)] menu.

Also the status of waiting is displayed as [Ready], the status of finishing backup is displayed as [Done].

5.2.2. Detailed backup history

If wanting to get the information of backup, click [Detail] button after selecting schedule.

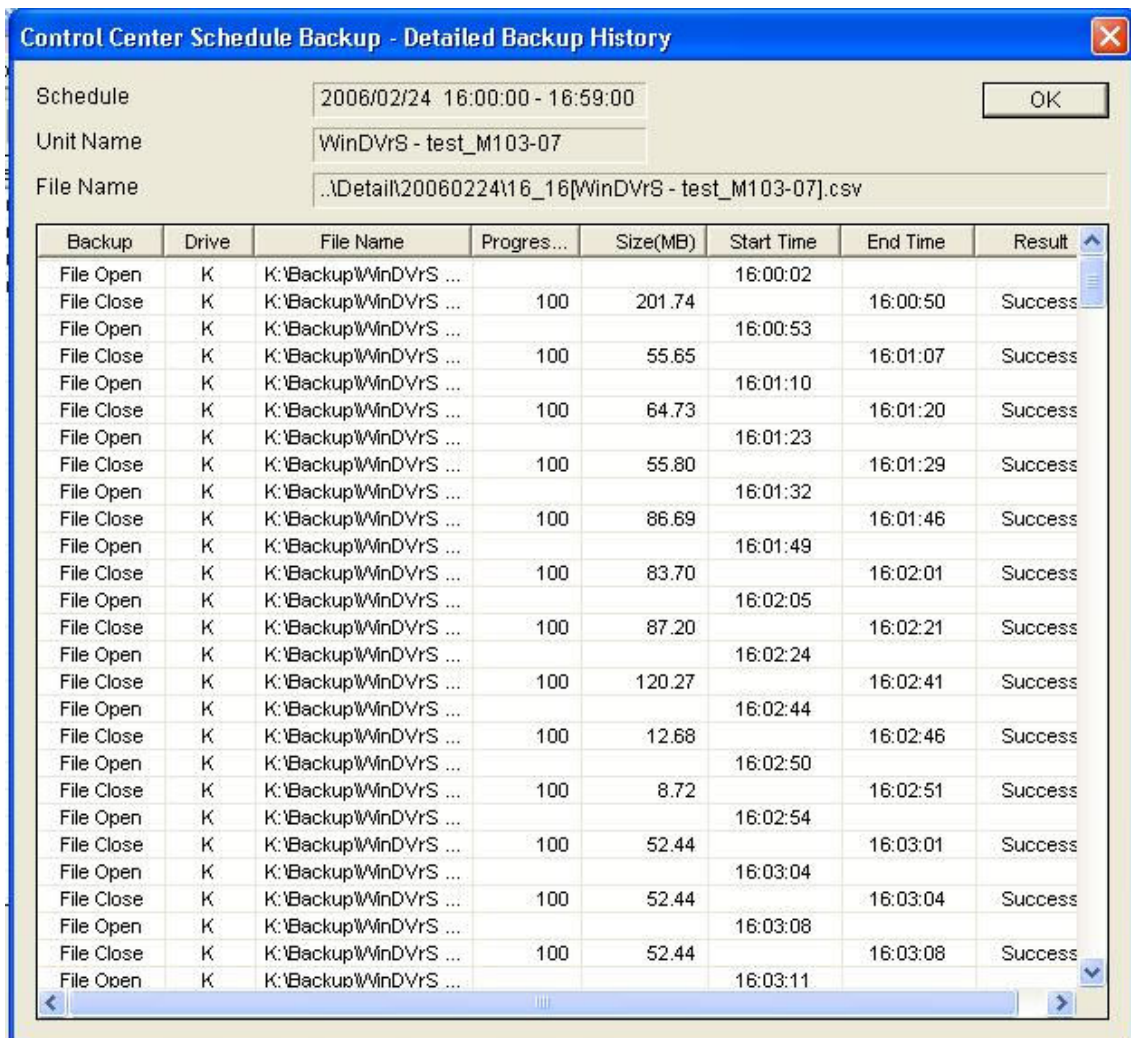

User can get the information of how many backup file is created and how big its size is (MB) if viewing the 'Detailed Backup History'.

5.2.3. Stop backup

Click [Stop] button after selecting schedule to stop backup.

If the backup is stopped, file will be created and all information also will be recorded.

Warning

* [Stop] button is activated only when selecting 'progress' backup.

APPENDIX

#1 Control Center Series Introduction and How to Configure System

#1.1 What is Control Center?

Control Center is multi-site managing software that control max 1000 units installed in remote area.

Control Center provides functions such as real-time monitoring, search & backup of recorded image, and setting. It also supports dual monitor and max 128 channels real-time monitoring simultaneously.

Therefore, Control Center provides designated motion area search, text search, and efficient search function.

It allows user to understand and deal with various situation of each unit. Also it provides function such as recording and searching event. If event is triggered, relevant image can be pop-up.

It is easily to control many units classified according to view set and map.

#1.2 Comparison Chart for Control Center Series

Series Function	Lite-W	Lite-D	Standard	Pro	Enterprise
The number of available Unit	4	16	1024	1024	1024
Multi Screen	1/4/9/13/16	1/4/9/13/ 16	1/4/9/13/26/25 36/49/64	1/4/9/13/26/25 36/49/64	1/4/9/13/26/25 36/49/64
Maximum number of Monitor	1	1	2	6	4+Extension Monitor
Distribute Management	No	No	No	No	Yes
Support Model	HB Series	HVRM Series	Both HVRM & HB Series	Both HVRM & HB Series	Both HVRM & HB Series
Map Function	No	No	Map, Device Registration	Special function (sub-map, section)	Special function (sub-map, section)
Unit, Layout Manage per User	No	No	No	Yes	Yes
Auto Action	Alarm popup	Alarm popup	Alarm popup	Alarm popup	Popup, relay, recording
Error Search	No	No	No	Yes	Yes
Keyboard Control	No	No	No	No	Yes
Price	Free	Free	Contact us	Contact us	Contact us

#1.3 Key Features and Configuraion of Control Center

Support Dual Monitor



- Hunt WESP based DVS (Digital Video Surveillance) solution makes multi security function with one or two monitors

View Set, Map



- Monitor several remote sites through the Control Center at the central management server, which makes convenient way to detect all devices installed on the same network over WESP.
- Manage the unit to register max. 64 channels as a View Set.
- Manage the registration of camera, sensor, relay-out, and audio out over the map
- Display event status over icon of a map and control audio out, relay-out, and etc through the icon

Alarm Management

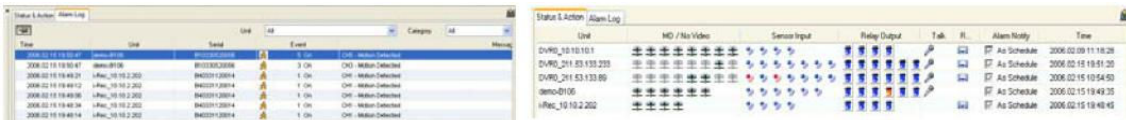

- Display Camera/Sensor Input/Relay Output/Recording of a product with visible status
- Display event list as a real time, which all can be recorded and searched
- Display video image popup detected by a alarm and be enable to schedule the event by a unit whether it will notify to a user

Playback



- Connect to recording server or open video files saved on its PC
- Instantly playback video, audio, text, or log history from a recording server
- Various search mode – Calendar, Time-Line, Log, Text, and Smart Search
- Simultaneously playback max. 16ch video by time, date, and event
- Zoom in/out or adjust brightness and contrast

- Backup the files from a recording server

Smart Search



- Very convenient way of finding recorded data to instantly view at a specific time among large number of files, which save time rather than searching Detected Motion files

Text Search



- Efficient text search by a date & keyword, which easily access to the corresponding time by double-clicking it.

Schedule Backup

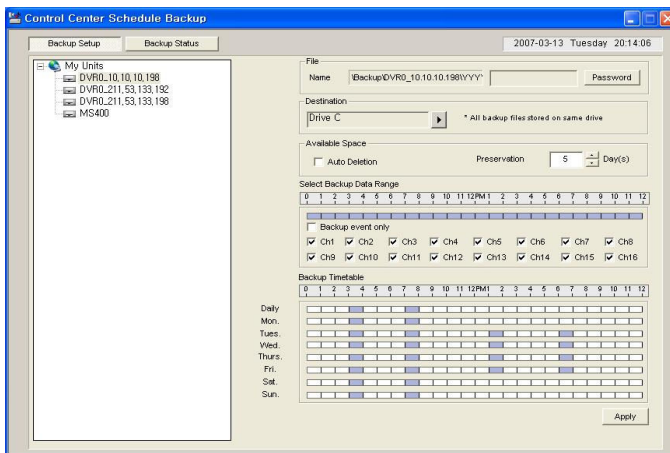

- Periodic schedule backup the video image from DVR or DVrS.

#1.4 System Diagram using Control Center

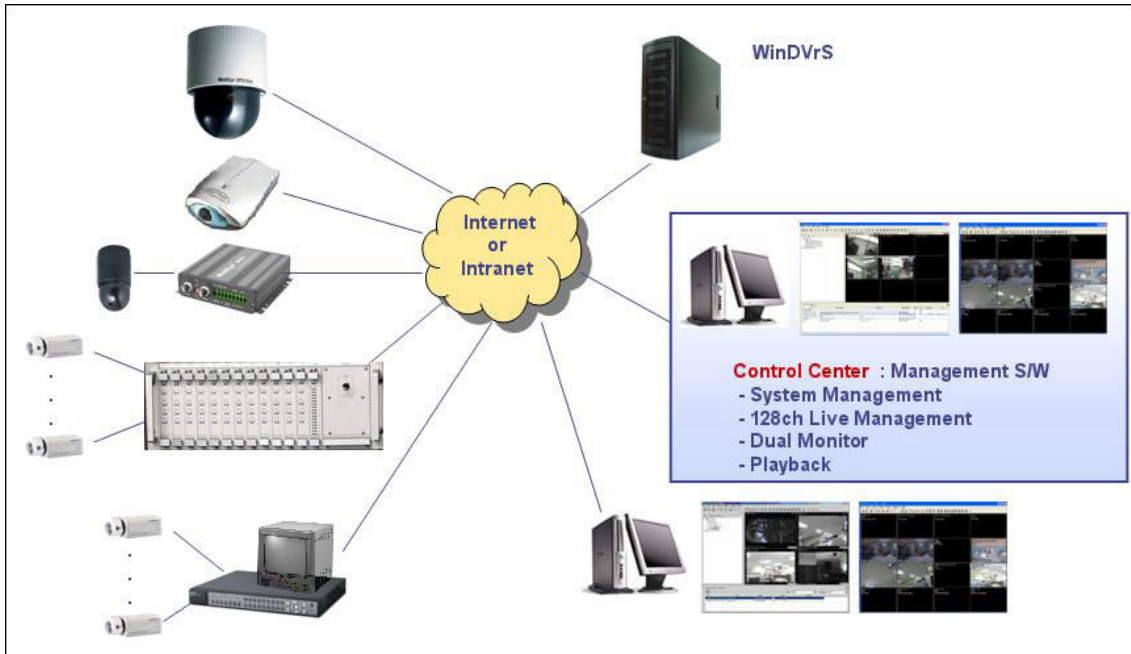

<Note>

Please refer to Control Center User Guide for further information.

#2 WinDVRs Introduction and System Configuration

#2.1 What is WinDVRs?

WinDVRs is storage software based on network. User can configure system, do real-time monitoring and search an image by using WinDVRs that saves live motion color pictures and event information from WESP(WebGate Embedded System Protocol)-based network camera(WebEye) or DVR helped by Control Center.

#2.2 Key Features of WinDVRs

- Schedule Recording
- Pre / Post Event Alarm
- Time Synchronization through NTP
- Remote Playback/Monitoring/Configuration
- Easy System Management using Configuration Tool
- Improved Searching Service
- Group User Management
- Image re-distribution service using RDS (Option)

#2.3 Key Features of WinDVRs Series

Specification / Model	WinDVRs	WinDVRs Pro
Max. Recording Ch.	Max. 128ch	Max. 128ch
Recording Speed	5 MByte/Sec	5 MByte/Sec
Simultaneous Real-Time Monitoring User#	Max. 5 (5 per ch)	Max. 1024 (Total 1024)
Simultaneous Playback User#	Max. 5	Max. 5
Network	100M above	100M above
Remote Software	Control Center (Standard / Pro / Enterprise)	Control Center (Standard / Pro / Enterprise)
RDS Availability	X	O

RDS (Image Redistribubtion Service) means that it provides simultaneous image service for more than several thousands users by ISP (Information Service Provider).

Image Redistribution Service (RDS) provided by Hunt can redistribute live imge of WebEye MPEG to several thousands users.

Since WebEye sends image only to RDS, it maximizes its performance without losing performance. For user point of view, it makes high quality service since it sends simultaneously high quality image to several hundred users.

System Diagram using WinDVrS

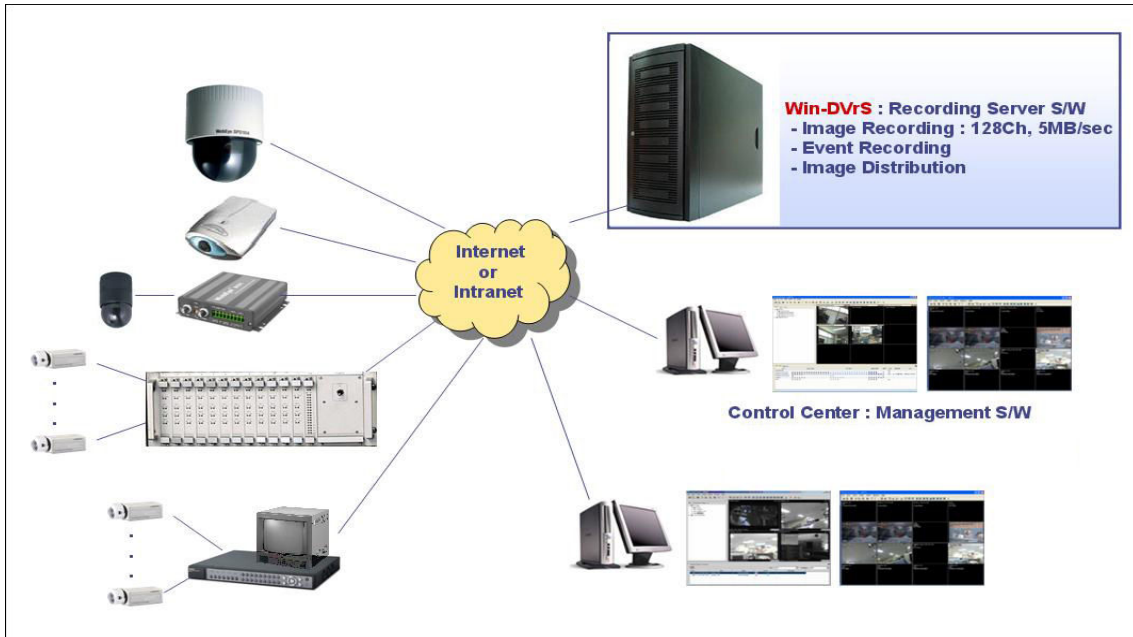

System Diagram using RDS

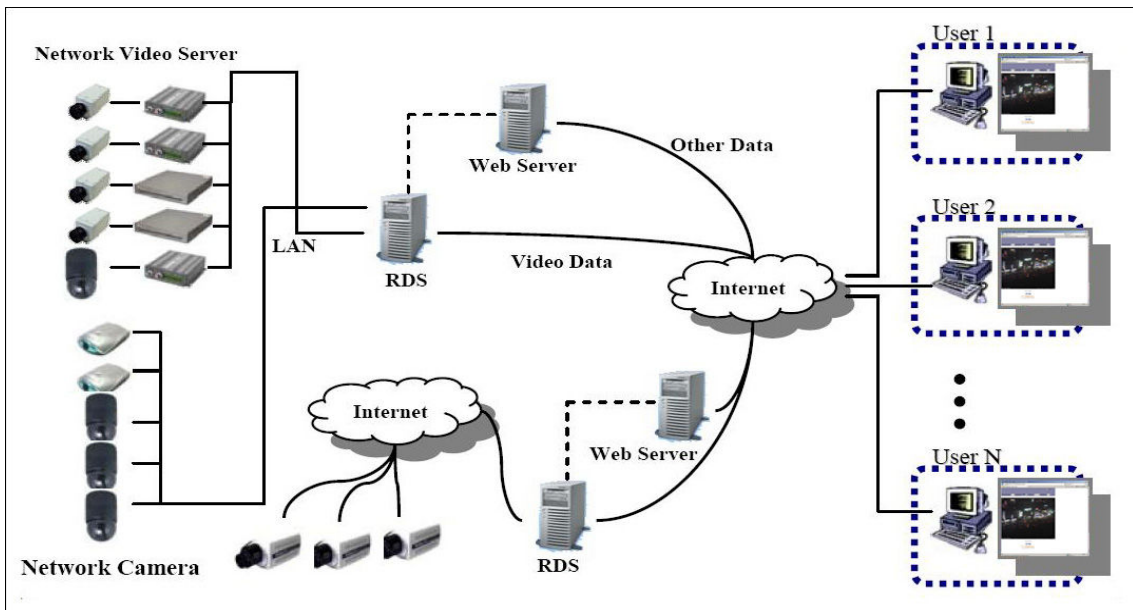

<Note>

Please refer to WinDVrS User Guide for further information.

#3 SDK Introduction for Powerful Application

#3.1 WESP (WEBGATE Embedded System Protocol) SDK

SDK (Software Development Kit) is development tool to make software without knowing its protocol. Since SDK is programmed to use same language with software language, it is easy to use and has merit of short-term software development period. The current SDK still has a problem to use since same products in same manufacture are mostly used with different SDK and providing function is for a few presenting SDK without all functions. Therefore, it should be made software per each model and had a difficulty to unite them.

For above reason, Hunt has united each protocol for Network camera & DVR products to WESP and WESP SDK. WESP SDK provides same usage for Network Camera or DVR, supports easy development environment & method, and support all function for them.

#3.2 Key Features of SDK

- Provide Same Usage for HVRM & HB Series Products
- Provide Easy Development Environment and Method
- Provide All Function for HVRM & HB Series Products

#3.3 SDK Configuration

SDK consists of Monitor, Discovery, Event, Config, PTZ, and Playback.

#3.4 SDK Usage Example

Live Monitoring Example

In case of making monitoring software to provide image from Network Camera or DVR and using image from the current software, Monitor Component can be used to view an image simply.

The below example illustrates source code for transmitting image per 30 frame with normal resolution, which upload Monitor component at the screen, press “Live monitoring!” button, and access to use IP address, port, ID, & password at the device.

[visual basic 6.0]

' If clicking button, try to connect

```
Private Sub Command_connect_Click()
```

```
    Call MonitorCtrl.Connect("192.168.63.1", 80, "guest", "guest_password")
```

```
End Sub
```

' If completing connection, request image

```
Private Sub MonitorCtrl_AckReceived(ByVal ackCode As Long, ByVal param As Long)
```

```
    If ackCode = ACK_CONNECT Then
```

```
        Call MonitorCtrl.PlayVideo(1, RESOLUTION_NORMAL, 30)
```

```
    End If
```

```
End Sub
```

<The Example of Sample Code>



Example of Recording

The recording function during an image monitoring at a specific point can be illustrated as the below simple code.

[visual basic 6.0]

```
Private Sub start_recording_Click()
```

```
    Call MonitorCtrl.StartRecording("c:\quickRec\", "testRecording.re3")
```

```
End Sub
```

```
Private Sub stop_recording_Click() MonitorCtrl.StopRecording
End Sub
```

Example of PTZ Control

In case of connecting to PTZ device, it is possible to make function to control PTZ using above simple code.

[visual basic 6.0]

```
Private Sub start_ptz_Click()
' Type channel number connected PTZ at parameter.
Call MonitorCtrl.StartPTZ(1)
End Sub
```

```
Private Sub stop_ptz_Click()
MonitorCtrl.StopPTZ
End Sub
```



Example of Component

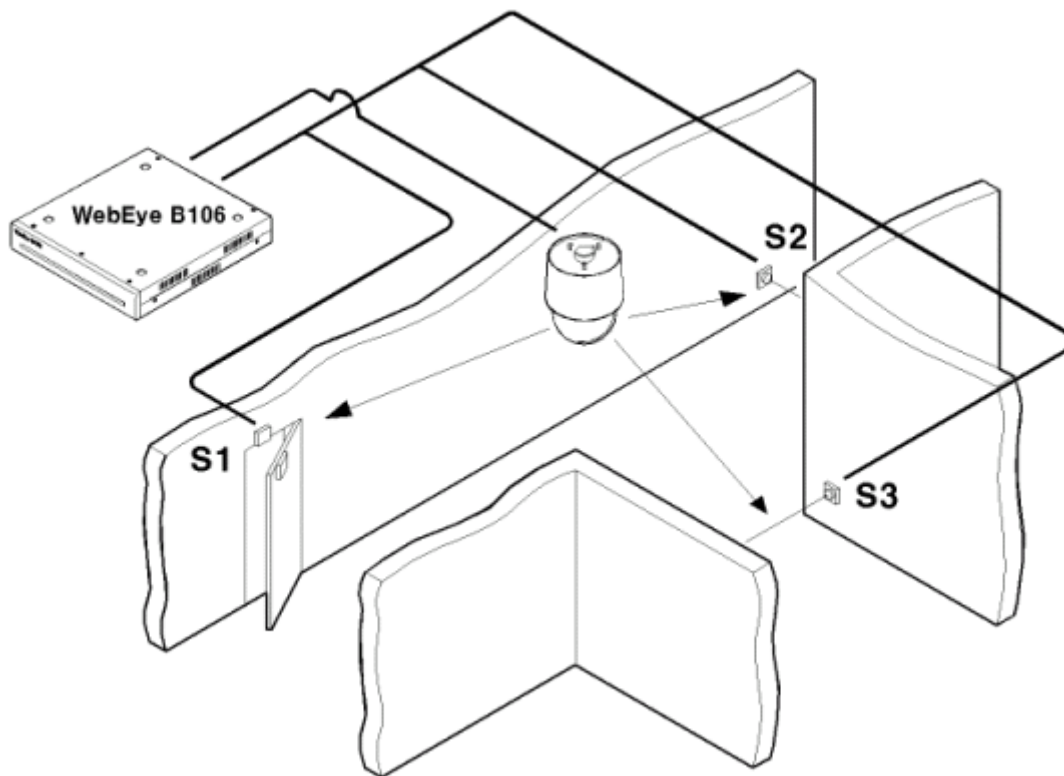

This example illustrates to control Sensor Input and PTZ preset using Monitor, PTZ, Event component when occurred sensor input, which is the function to automatically move to special preset.

1. Make a connection between dome camera and sensor shown as above figure.
2. Set preset point at Dome camera (Config component can be used for setting preset)
3. Make software to move to corresponding preset according to the number of sensor input using below code.

[visual basic 6.0]

‘ If clicking start button, Event, Monitor, and PTZ ActiveX component connect to the device.

Private Sub Command_start_Click()

 Call Event1.Connect(“192.168.63.1”, 80, “guest”, “guest_password”, 0)

 Call Monitor1.Connect(“192.168.63.1”, 80, “guest”, “guest_password”)

 Call PTZ1.Connect(“192.168.63.1”, 80, “guest”, “guest_password”)

End Sub

‘ If clicking stop button, connection is closed.

Private Sub Command_stop_Click()

 Monitor1.Disconnect

```

PTZ1.Disconnect
Event1.Disconnect
End Sub

‘ The execution function when occurred event at server.
‘ If Event category is “1” and EventID is “16”, Sensor Input means “on”.
‘ Then, move command executes to move corresponding preset to same number of sensor input.
Private Sub Event1_EventReceived(ByVal pIEvent As WESPEVENTLibCtl.IEvent)
    If pIEvent.EventCategory = 1 And pIEvent.EventID = 16 Then
        Call PTZ1.GotoPreset(pIEvent.NumberField)
    End If

    If pIEvent.EventCategory = 1 And pIEvent.EventID = 17 Then
        ‘ If Sensor input is “off”, there is nothing to work.
    End If
End Sub

‘ If Monitor component is succeed in connection, image will be played.
Private Sub Monitor1_AckReceived(ByVal AckCode As Long, ByVal Param As Long)
    If AckCode = ACK_CONNECT Then
        Monitor1.PlayVideo 1, 3, 15
    End If

```

HUNT ELECTRONIC USA INC.

11790 Jersey Blvd.

Rancho Cucamonga, CA 91730

Tel: (888)993-4868, (909)987-6999

Fax: (909)987-6997

techsupport@huntcctv.com

www.huntcctv.com

The contents of this manual can be different in accordance with Software upgrade and design/ specification can be partly modified without prior notice to user.